

NASA Technical Memorandum 104566, Vol. 14

SeaWiFS Technical Report Series

Stanford B. Hooker and
Elaine R. Firestone, Editors

Volume 14, The First SeaWiFS Intercalibration Round-Robin Experiment, SIRREX, July 1992

James L. Mueller



September 1993



NASA Technical Memorandum 104566, Vol. 14

SeaWiFS Technical Report Series

Stanford B. Hooker, Editor
*NASA Goddard Space Flight Center
Greenbelt, Maryland*

Elaine R. Firestone, Technical Editor
*General Sciences Corporation
Laurel, Maryland*

Volume 14, The First SeaWiFS Intercalibration Round-Robin Experiment, SIRREX, July 1992

James L. Mueller
*Center for Hydro-Optics and Remote Sensing
San Diego State University
San Diego, California*

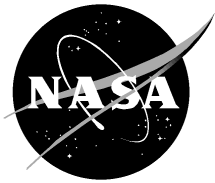

National Aeronautics and
Space Administration

Goddard Space Flight Center
Greenbelt, Maryland 20771

1993

ABSTRACT

This report presents the results of the first Sea-viewing Wide Field-of-view Sensor (SeaWiFS) Intercalibration Round-Robin Experiment (SIRREX-1), which was held at the Center for Hydro-Optics and Remote Sensing (CHORS) at San Diego State University (SDSU) on 27–31 July 1992. Oceanographic radiometers to be used in the SeaWiFS Calibration and Validation Program will be calibrated by individuals from the National Aeronautics and Space Administration's (NASA) Goddard Space Flight Center (GSFC), CHORS, and seven other laboratories. The purpose of the SIRREX experiments is to assure the radiometric standards used in all of these laboratories are referenced to the same scales of spectral irradiance and radiance, which will be maintained by GSFC and periodically recalibrated by the National Institute of Standards and Technology (NIST). The spectral irradiance scale of GSFC's FEL lamp number F269 (recalibrated by NIST in October 1992) was transferred to lamps belonging to the 9 participating laboratories; 1 set of lamp transfer measurements (involving 4 of the lamps) was precise to within less than 1% and meets SeaWiFS goals, but a second set (involving another 14 lamps) did not. The spectral radiance scale of the GSFC 40-inch integrating sphere source was transferred to integrating sphere radiance sources belonging to four of the other laboratories. Reflectance plaques, used for irradiance-to-radiance transfer by five of the laboratories, were compared, but spectral bidirectional reflectance distribution functions (BRDFs) were not determined quantitatively. Also reported here are results of similar comparisons (in October 1992) between the GSFC scales of spectral irradiance and radiance and those used by the Hughes/Santa Barbara Research Center (SBRC) to calibrate and characterize the SeaWiFS instrument. This first set of intercalibration round-robin experiments was a valuable learning experience for all participants, and led to several important procedural changes, which will be implemented in the second SIRREX, to be held at CHORS in June 1993.

1. INTRODUCTION

The Sea-viewing Wide Field-of-view Sensor (SeaWiFS) ocean color radiometer is scheduled to be launched in early 1994. It will operate in a sun-synchronous orbit with an expected lifetime of 5 years. The National Aeronautics and Space Administration (NASA) will carry out a program to acquire the global SeaWiFS data set, validate and monitor its accuracy and quality, process the radiometric data into geophysical units, and distribute it to the scientific community in the US and abroad. The SeaWiFS data products figure as prominent components of major scientific programs studying global change, including the Joint Global Ocean Flux Study (JGOFS) and the Global Ecosystem (GLOBEC) programs.

Two important goals of the SeaWiFS Project are to determine from the radiance measurements, 1) normalized water-leaving radiance with an accuracy of 5%, and 2) chlorophyll *a* concentration with an accuracy of 30% (Hooker et al. 1992). These are ambitious goals, and can only be achieved by augmenting the SeaWiFS measurements with a program of ongoing validation measurements to verify the radiometric precision and long-term stability of the SeaWiFS instrument's radiance responsivities, and to validate the atmospheric correction models and algorithms used to convert SeaWiFS radiances to normalized water-leaving radiances. One of the principal approaches to this critical aspect of validation will be frequent direct comparisons between SeaWiFS estimates and *in situ*

measurements of water-leaving radiance collected during cruises and from a marine optical buoy (MOBY). Because the desired result is to validate normalized water-leaving radiances derived from SeaWiFS data to within 5%, the comparative *in situ* radiometric measurements must be calibrated to be accurate within less than 5%.

The only economically feasible approach for acquiring a large and globally distributed sample of *in situ* radiometric measurements for SeaWiFS validation is to solicit contributions of data from the oceanographic community at large, and to somehow provide assurance that the aggregate data set will be of uniform quality and accuracy to within 5% (or at least be internally consistent to that level of precision). The SeaWiFS Project, located at the NASA Goddard Space Flight Center (GSFC), is addressing this problem through the SeaWiFS Calibration and Validation Program (McClain et al. 1992). At the outset, the Project sponsored a workshop to draft protocols for ocean optics measurements to support SeaWiFS validation (Mueller and Austin 1992), which included instrument performance specifications and requirements for instrument characterization and calibration.

Of the oceanographers and institutions expected to contribute oceanic radiometer measurements to the SeaWiFS validation database, only a small number are equipped to calibrate and characterize radiometric instruments, and fewer still are able to meet the exacting standards recommended for the Project. Currently, the laboratories which engage in at least some aspects of the characterization and

calibration of oceanographic radiometers include the following:

- GSFC,
- the Center for Hydro-Optics and Remote Sensing (CHORS) located at San Diego State University (SDSU),
- the Department of Physics at the University of Miami (UM),
- the University of California at Santa Barbara (UCSB), and
- the Moss Landing Marine Laboratory (MLML) at San Jose State University (SJSU) in cooperation with Dennis Clark at the National Oceanic and Atmospheric Administration (NOAA).

Several manufacturers of instruments engage in instrument characterization and calibration including, for example,

- Biospherical Instruments, Inc. (BSI) in San Diego, California, and
- Satlantic, Inc. in Halifax, Nova Scotia, Canada.

The strategy adopted for SeaWiFS validation is to calibrate all involved instruments within the network consisting of these, and possibly a few additional, laboratories. In recognition of the need to maintain internal consistency between calibrations of *in situ* instruments and that of the SeaWiFS instrument itself, the SeaWiFS Project, under the Calibration and Validation element, has implemented an ongoing series of SeaWiFS Intercalibration Round-Robin Experiments (SIRREXs). The purpose of the SIRREX program is to transfer the National Institute of Standards and Technology (NIST) scales of spectral irradiance and radiance through GSFC to 1) all participating laboratories in the SeaWiFS ocean color community, and 2) to the calibration standards used to calibrate the SeaWiFS instrument for radiance responsivity. This process is illustrated schematically in Fig. 1.

The first round-robin, SIRREX-1, was carried out from 27–31 July 1992 at CHORS. The objectives were as follows:

- a) To intercalibrate FEL lamp working standards of spectral irradiance used at the participating laboratories and to reference each to the NIST scale of spectral irradiance via a secondary standard to be maintained at GSFC;
- b) To intercalibrate the integrating sphere sources of spectral radiance used by the participants;
- c) To intercompare plaques used to transfer the scale of spectral irradiance from an FEL lamp to a scale of spectral radiance; and
- d) To intercompare transfer radiometers and other support electronics (most critically shunts and voltmeters) used to support radiometric calibrations at each laboratory.

The participants in SIRREX-1, and the sources and radiometers each contributed to the experiments, are listed in Table 1.

This report describes the methods and results of the first SIRREX (July 1992), discusses the significance of the results in terms of the relative readiness of the calibration community to meet the SeaWiFS radiometric goals, and recommends specific procedural guidelines for the next SIRREX. In addition, this report describes subsequent activities to:

- i) Determine the temporal stability of the Optronics 746/Integrating Sphere Irradiance Collector (ISIC) spectroradiometer, used as a transfer radiometer for lamp intercomparisons (Fig. 1);
- ii) Intercalibrate the GSFC spectral irradiance and radiance scales with those at the Hughes/Santa Barbara Research Center (SBRC), which have been used to calibrate the SeaWiFS instrument; and
- iii) Modify equipment and procedures to overcome deficiencies noted during SIRREX-1.

2. METHODS

This section briefly describes methods for transferring NIST-traceable scales of spectral irradiance and radiance to the laboratories participating in SIRREX-1. The results of the tests are presented in Section 3.

2.1 Irradiance: Standard Lamps

All of the participating laboratories base their absolute calibrations of irradiance and radiance responsivities on the NIST scale of spectral irradiance, which is transferred to the American scientific and engineering community via calibrated tungsten-halogen lamps, usually FEL lamps and less frequently DXW lamps (Walker et al. 1987). Some laboratories acquire a calibrated FEL lamp standard of spectral irradiance directly from NIST, but more typically, a laboratory will base its irradiance scale on a lamp which has been calibrated and certified as traceable to the NIST scale by a commercial standardizing laboratory. This transfer is illustrated schematically in the upper-left portion of Fig. 1. The transfer begins with NIST, and propagates to laboratories either directly or through commercial providers of lamps; occasionally a user will have a lamp recalibrated by NIST. In all cases, a laboratory will purchase additional seasoned, but uncalibrated lamps, and transfer the spectral irradiance scale from their calibrated lamp using a transfer radiometer. These less expensive working standards are then used for actual calibration experiments to avoid aging and, thus, expending the useful working life of, their primary local scale reference lamp.

A laboratory will periodically intercompare all of their working standard lamps and their primary reference lamp

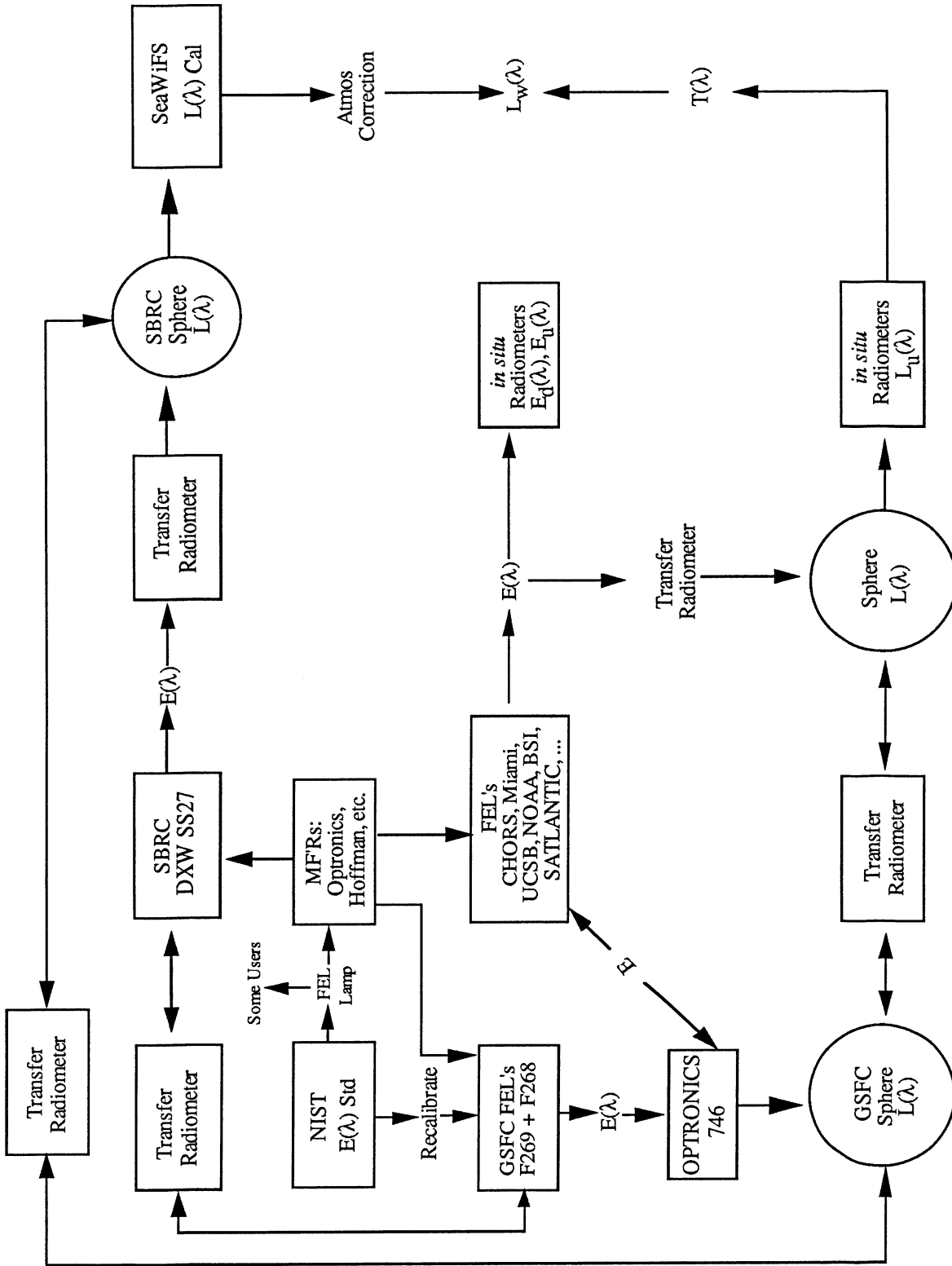

Fig. 1. Schematic illustration of SIRREX-1 validation process.

Table 1. Participants in the July 1992 SIRREX and their intercalibration and radiometric sources (see Appendix D). All lamps are FEL lamps except those designated by the † symbol, which are DXW lamps.

<i>Organization</i>	<i>Contact</i>	<i>Lamps</i>	<i>Sphere</i>	<i>Plaque</i>	<i>Radiometer</i>
BSI	R. Booth	F310	20 inch	Spectralon	BSI 6-channel radiometer and QED200
	G. Adelman	F321 91453			
CHORS	J. Mueller	90572	40 inch	Spectralon	QED200
	R. Austin	91348			
	C. Titus	91534			
GSFC	J. McLean	F268	42 inch		Optronics 746A
	J. Cooper	F269			
MLML	M. Yarbrough				
	M. Feinholz				
NCCOSC/NRaD	R. Howarth	F265			
	C. Johnson				
NIST	C. Cromer				PR714 and NIST Calibrated Photodetectors
NOAA	D. Clark	F307 F308	Optonics 420M	Spectralon	
Satlantic	S. McLean	S724† S721†			Satlantic 7-channel radiometer and QED200
SRT	D. Goebel				
SIO/MPL	R. Johnson	F12L			
UCSB	R. Smith	F219	20 inch	Spectralon	
	D. Menzies	F303			
UM	K. Voss	F12G			
		F12H			

†DXW lamps.

to maintain an internally consistent scale of spectral irradiance, and to detect cases when a lamp begins to either become unstable, or to otherwise fail in a subtle way (a lamp usually becomes an unreliable source of spectral irradiance long before it burns out). The SIRREX program extends this internal consistency maintenance throughout the several laboratories participating in calibration of instruments for SeaWiFS validation.

During SIRREX-1, the spectral irradiance scale of GSFC FEL lamp F269 was transferred to 17 other lamps belonging to the various participating laboratories as summarized in Table 1. The F269 irradiance scale was recalibrated by NIST in October 1992, to provide a fresh standard, traceable to NIST, as the basis for intercalibration of all radiometers involved in SeaWiFS validation. Another GSFC FEL lamp, F268, was also recalibrated by NIST to provide a working reference to verify the long-term stability of F269 as the primary tie to the NIST scale of spectral irradiance.

Transfer of the F269 scale of spectral irradiance to other lamps follows the procedures for spectral irradiance calibrations described in Walker et al. (1987) and shown in Fig. 1. A small ISIC is attached (at its exit port) to the entrance slit of an Optronics 746 spectroradiometer (a single-monochromator radiometer system, with a 750 nm blaze grating and a silicon detector). Lamp F269 was mounted

to illuminate the entrance port of the 746/ISIC, which was placed perpendicular to the center of the lamp filament at a distance of 50 cm (by convention, measured to the front surface of the lamp electrical connection posts).

The calibration procedure used during SIRREX-1 was as follows:

1. The lamp and 746/ISIC were both powered on and warmed up for approximately 20 minutes.
2. The irradiance responsivity of the 746/ISIC was then determined by measuring the known spectral irradiance output from lamp F269.
3. The calibrated responsivity of the 746/ISIC was used to measure the spectral irradiance emitted by each of the other lamps. (The first measurement is always made immediately on the reference lamp, F269, to provide an initial measure of the transfer precision.)
4. Each lamp was then powered down and replaced by the next lamp to be calibrated, which was allowed to warm up for approximately 15 minutes before its spectral irradiance output was measured with the 746/ISIC.
5. The above procedure was repeated until all of the lamps were calibrated.

6. At, or near, the end of a transfer session, the reference lamp (F269) was measured once again to test the stability of the radiometer's calibration through the duration of the entire procedure; this final precision test on F269 was not performed on 30 July, but it was during the session of 31 July (Section 3.2).

2.2 Lamps, Spheres, and Plaques

Transfer of the NIST scale of spectral irradiance to a scale of spectral radiance is accomplished by one of three methods. In the method used at GSFC, known irradiance from an FEL lamp standard of spectral irradiance is first measured by the 746/ISIC, in a setup identical to that described in Section 2.1 for lamp transfer. The responsivity of the 746/ISIC to spectral irradiance is thus determined. The entrance port of the 746/ISIC is then positioned at a known distance from the exit port of a larger integrating sphere, which is illuminated by stable lamp sources. The apertures of the two spheres must be parallel and aligned on the common perpendicular joining their two centers. From the distance between the ports of the two spheres and their respective areas, it is possible to calculate from the measured irradiance, the radiance in the exit port of the integrating sphere radiance source, and thus to transfer the scale of spectral irradiance from the lamp to a scale of spectral radiance for the sphere.

In the second approach, the spectral irradiance from a calibrated lamp is directed at normal incidence onto a plaque for which the bidirectional reflectance distribution function (BRDF) is accurately known for at least one viewing angle. The spectral radiance reflected from the plaque is calculated as the product of the BRDF and the known incident spectral irradiance from the lamp. The spectral responsivity of a radiance sensor is then calibrated by measuring the spectral radiance reflected from the plaque at the viewing angle for which the BRDF is known. This technique may be used to calibrate an instrument directly, by viewing the plaque, or to determine the spectral radiance scale of an integrating sphere source, by using a transfer radiometer.

A third approach, which was used during SIRREX-1, is to use the first method to determine the spectral radiance scale of one reference sphere source (in this case, the GSFC 42-inch integrating sphere), and to then use that source to calibrate a narrow field-of-view transfer spectroradiometer. During SIRREX, the radiance scale of the GSFC 42-inch sphere was transferred to several other spheres, using a commercial Photo Research PR714 Spectrascan spectroradiometer provided by NIST.

3. RESULTS

This section summarizes the results for spectral irradiance scale transfer and comparisons for lamp sources (Section 3.1) and integrating spheres (Section 3.2), reflectance

plaque intercomparisons (Section 3.3), shunt and voltmeter tests (Section 3.4), stability tests of the Optronics 746 spectrophotometer (Section 3.5), and GSFC and SBRC spectral irradiance and radiance source comparisons during October 1992 (Section 3.6).

3.1 Lamp Sources

The NIST (October 1992) calibrated scale of spectral irradiance of FEL lamp F269 was transferred, by post-calculation from measurements on 30 and 31 July 1992, to the other 17 lamps listed in Table 1. GSFC FEL lamp F269, originally calibrated by its manufacturer (Optronics) and subsequently recalibrated by NIST in October 1992, provided the reference scale of spectral irradiance for all round-robins between participating laboratories. GSFC FEL lamp F268 was recalibrated by NIST in October 1992, and will provide a comparison benchmark against which F269 will be periodically tested for possible drift.

Transfer of the (NIST October 1992) F269 spectral irradiance scale to the other lamps was done in two separate sessions, using the equipment and procedures described in Section 2.1, on 30 and 31 July 1992. On 30 July, The GSFC Optronics 746/ISIC spectroradiometer was calibrated against lamp F269 at 2015 PDT, and that calibration was then used to measure the irradiance spectra of lamps F269 (as a test of transfer precision at the beginning of the procedure), F268, F307, and F308; a post-session test measurement of F269 was not performed. The results of the transfer precision test of F269 and comparisons to its NIST and original Optronics calibration, together with similar results for the other 3 lamps, are given in Table 2 and illustrated in Figs. 2–5, respectively. The transfer procedure began at 2015 PDT and was completed for the 4 lamps at 2216 PDT.

On 31 July 1992, the Optronics 746/ISIC and lamp F269 were powered on, and both were warmed up for approximately 20 minutes. The spectroradiometer was then calibrated with F269, and then a precision test measurement of F269 was repeated at 0800 PDT. Between 0800 and 1807 PDT, the spectral irradiance output of the remaining 14 lamps were measured with the 746/ISIC using the responsivity table derived from the initialization measurements of F269. A second stability and precision test was made by remeasuring the output of lamp F269 at 1430 PDT. The F269 spectra measured at 0800 and 1430 PDT (31 July 1992) are listed and compared in Table 3, and the apparent change (0800 relative to 1430) is illustrated in Fig. 6.

On the assumption that the 746/ISIC was not warmed up adequately at 0800, the radiometer's responsivity was recalculated based on the F269 measurements at 1430 PDT and calculated the irradiance scale transfers on that basis. The results of these scale transfers, and comparisons to previous calibration scales, are given in Tables 4 (F321, 91453, and F310), 5 (90572, 91348, and 91534), 6 (F219,

Table 2. Irradiance scale transfer from GSFC lamp F269 on 30 July 1992 to lamps: F268 (GSFC), F307 (NOAA), and F308 (NOAA). (Irradiances under each lamp column are in units of $\mu\text{W cm}^{-2} \text{nm}^{-1}$.)

λ [nm]	F269			F268			F307		F308	
	RR	NIST	OI	RR	NIST	OI	RR	OI	RR	NIST
400	2.3119	2.3410	2.3000	2.2986	2.2770	2.2300	2.2603	2.2800	2.3340	2.3530
405	2.4995	2.5380	2.4936	2.4009			2.3850		2.5056	
410	2.7431	2.7430	2.6962	2.7410			2.7504		2.7873	
415	2.9504	2.9570	2.9070	2.8837			2.9273		2.9521	
420	3.2290	3.1790	3.1260	3.1007			3.1863		3.2576	
425	3.3978	3.4090	3.3530	3.4039			3.4161		3.4770	
430	3.6451	3.6450	3.5877	3.5520			3.6244		3.6968	
435	3.8957	3.8900	3.8300	3.8199			3.8601		3.9314	
440	4.1215	4.1410	4.0796	4.0753			4.0907		4.1986	
445	4.4010	4.4000	4.3359	4.3211			4.3836		4.4461	
450	4.6835	4.6650	4.6000	4.5945	4.5580	4.4700	4.6422	4.5700	4.7247	4.6870
455	4.9248	4.9390	4.8732	4.8367			4.8925		4.9806	
460	5.2315	5.2190	5.1535	5.1267			5.1709		5.2812	
465	5.4865	5.5050	5.4393	5.4040			5.4504		5.5458	
470	5.7888	5.7960	5.7306	5.6686			5.7431		5.8345	
475	6.0797	6.0930	6.0269	5.9896			6.0459		6.1607	
480	6.4082	6.3940	6.3278	6.2953			6.3613		6.4571	
485	6.6974	6.6990	6.6330	6.5799			6.6407		6.7621	
490	7.0173	7.0090	6.9421	6.9077			6.9711		7.0750	
495	7.3187	7.3220	7.2534	7.1928			7.2468		7.3906	
500	7.6381	7.6380	7.5700	7.5035	7.4830	7.3800	7.6045	7.5200	7.7391	7.6720
505	7.9593	7.9570	7.8962	7.8325			7.9276		8.0386	
510	8.2606	8.2790	8.2262	8.1409			8.2307		8.3354	
515	8.6215	8.6030	8.5558	8.4918			8.5639		8.6792	
520	8.9435	8.9280	8.8851	8.7895			8.8875		9.0135	
525	9.2591	9.2560	9.2131	9.1085			9.1769		9.3413	
530	9.5865	9.5840	9.5388	9.4254			9.5328		9.6671	
535	9.9107	9.9130	9.8613	9.7533			9.8451		9.9893	
540	10.2280	10.2430	10.1797	10.0879			10.1644		10.3172	
545	10.5759	10.5720	10.4919	10.4029			10.5264		10.6624	
550	10.9210	10.9010	10.8000	10.7303		10.6000	10.8376	10.8000	10.9807	
555	11.2367	11.2290	11.1030	11.0514	11.0100	10.9000	11.1440	11.1000	11.3062	11.2700
560	10.8083	11.5560	11.4076	10.6374			10.7335		10.8937	
565	11.9086	11.8820	11.7216	11.7021			11.8168		11.9775	
570	12.2094	12.2060	12.0408	12.0098			12.1154		12.2915	
575	12.5370	12.5280	12.3640	12.3287			12.4267		12.5983	
580	12.8425	12.8480	12.6902	12.6345			12.7515		12.9204	
585	13.1751	13.1660	13.0180	12.9530			13.0640		13.2306	
590	13.4947	13.4810	13.3464	13.2720			13.3908		13.5689	
595	13.7966	13.7920	13.6735	13.5766			13.7180		13.8752	

RR: Round-robin transfer on 31 July 1992.

NIST: Calibration by NIST in October 1992.

OI: Original irradiance scale calibration by Optronics, Inc.

Table 2. (cont.) Irradiance scale transfer from GSFC lamp F269 on 30 July 1992 to lamps: F268 (GSFC), F307 (NOAA), and F308 (NOAA). (Irradiances under each lamp column are in units of $\mu\text{W cm}^{-2} \text{ nm}^{-1}$.)

λ [nm]	F269			F268			F307		F308	
	RR	NIST	OI	RR	NIST	OI	RR	OI	RR	NIST
600	14.0809	14.1000	14.0000	13.8502	13.8400	13.7000	13.9784	13.9000	14.1493	14.1500
605	14.4067	14.4020	14.3271	14.1829			14.3108		14.4947	
610	14.7102	14.7000	14.6509	14.4799			14.6181		14.7947	
615	15.0132	14.9930	14.9683	14.7886			14.9383		15.1105	
620	15.3003	15.2830	15.2783	15.0583			15.2270		15.3956	
625	15.5711	15.5680	15.5794	15.3329			15.5061		15.6649	
630	15.8544	15.8490	15.8702	15.6126			15.7833		15.9539	
635	16.1330	16.1270	16.1492	15.8959			16.0842		16.2516	
640	16.3984	16.3990	16.4148	16.1412			16.3198		16.4841	
645	16.6636	16.6680	16.6636	16.4026			16.5816		16.7605	
650	16.9338	16.9310	16.9000	16.6716		16.5000	16.8413	16.8000	17.0263	
655	17.1917	17.1910	17.1232	16.9336			17.1448		17.3169	
660	17.4652	17.4450	17.3456	17.2006			17.4030		17.5820	
665	17.6946	17.6950	17.5814	17.4419			17.6410		17.8171	
670	17.9557	17.9400	17.8235	17.7078			17.8956		18.0759	
675	18.1782	18.1790	18.0698	17.9204			18.1193		18.3108	
680	18.4029	18.4150	18.3185	18.1347			18.3594		18.5406	
685	18.6421	18.6450	18.5678	18.3913			18.5991		18.7854	
690	18.8722	18.8700	18.8157	18.6095			18.8225		19.0213	
695	19.0764	19.0880	19.0644	18.8085			19.0412		19.2244	
700	19.3070	19.3000	19.3000	19.0330	18.9700	18.9000	19.2649	19.1000	19.4475	19.3600
705	19.5109	19.5040	19.5039	19.2304			19.4618		19.6511	
710	19.6998	19.7010	19.6928	19.4194			19.6507		19.8399	
715	19.8912	19.8920	19.8783	19.6171			19.8631		20.0457	
720	20.0841	20.0770	20.0570	19.8022			20.0418		20.2392	
725	20.2281	20.2550	20.2291	19.9593			20.2069		20.3909	
730	20.4072	20.4290	20.3949	20.1152			20.3644		20.5710	
735	20.5453	20.5960	20.5546	20.2862			20.5165		20.7253	
740	20.6989	20.7580	20.7085	20.4364			20.6916		20.8739	
745	20.8896	20.9140	20.8564	20.6109			20.8603		21.0583	
750	21.0189	21.0650	21.0000	20.7472		20.6000	21.0116	20.9000	21.1952	

RR: Round-robin transfer on 31 July 1992.

NIST: Calibration by NIST in October 1992.

OI: Original irradiance scale calibration by Optronics, Inc.

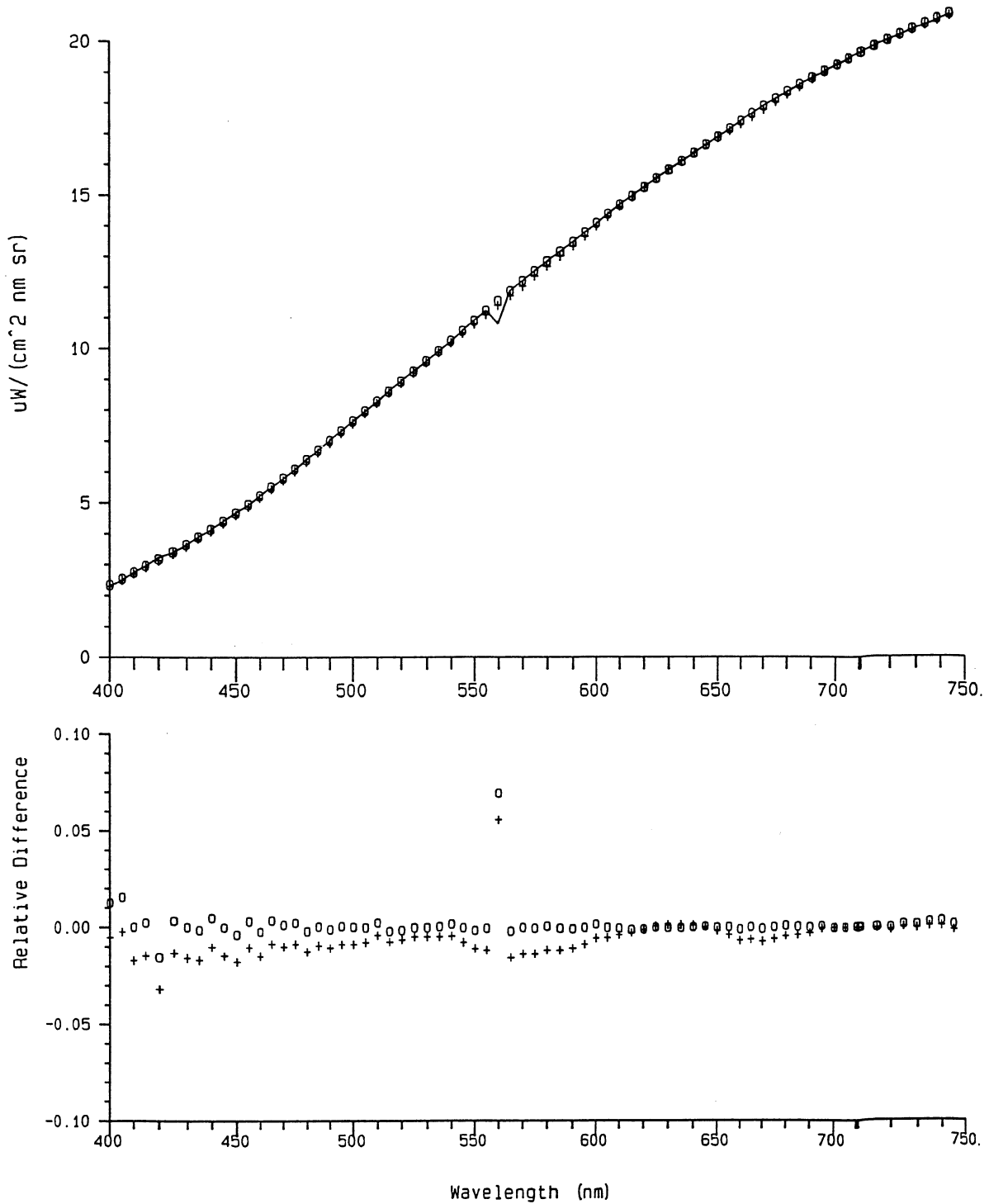

Fig. 2. Apparent spectral irradiance of lamp F269 (top panel, solid line) using scale transfer from the NIST October 1992 F269 scale, during SIRREX-1 on 30 July 1992, compared to the NIST October 1992 calibrated irradiance scale (0), and original calibration by Optronics (+), of FEL lamp F269. The bottom panel illustrates the differences between the NIST (0) and Optronics (+) irradiance scales, relative to the SIRREX-1 30 July 1992 scale transfer from F269.

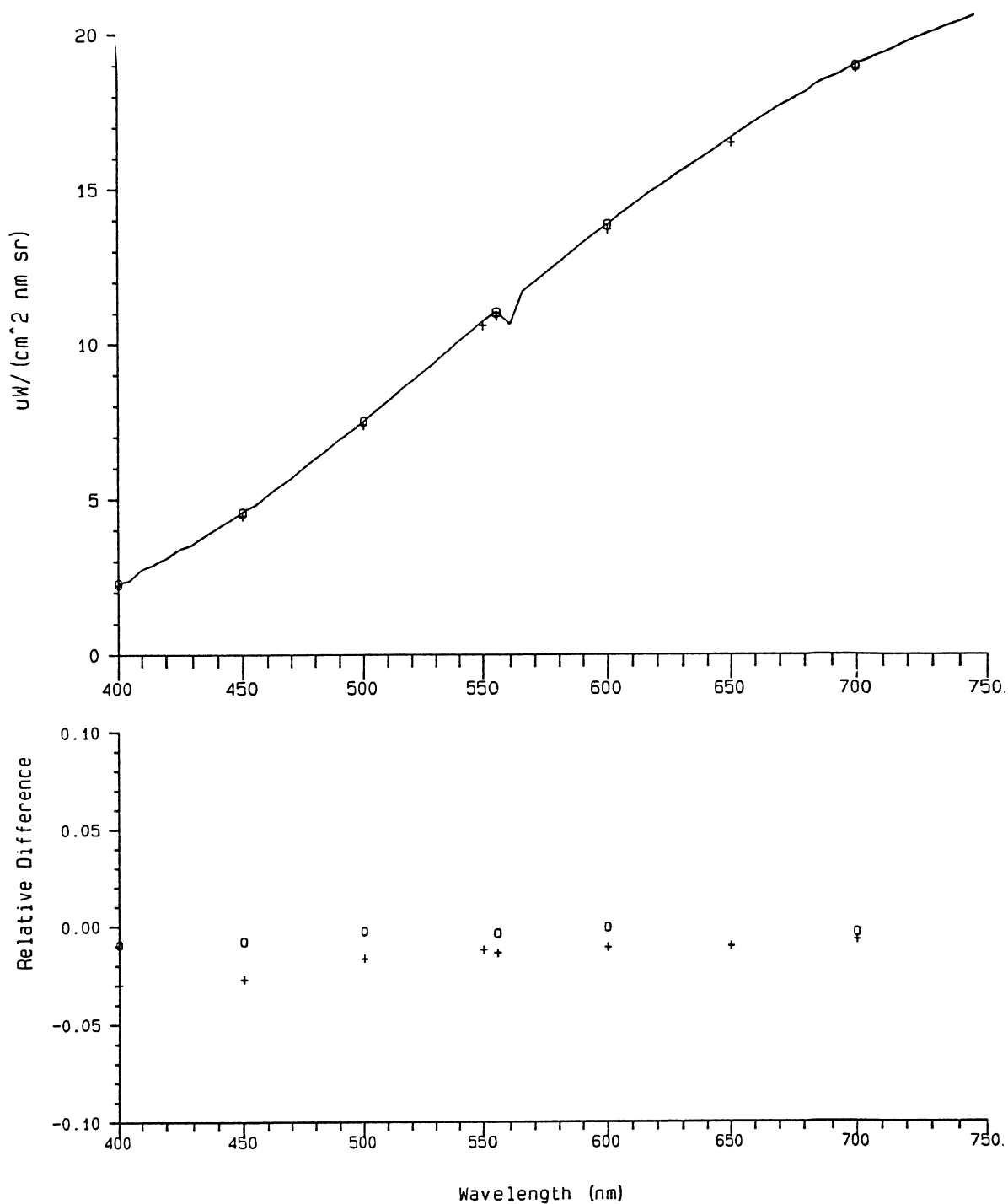

Fig. 3. Spectral irradiance of lamp F268 (top panel, solid line) using scale transfer from the NIST October 1992 F269 scale, during the SIRREX-1 lamp transfer on 30 July 1992, compared to the NIST October 1992 calibrated irradiance scale (*), and original calibration by Optronics (+), of FEL lamp F268. The bottom panel illustrates the differences between the NIST (0) and Optronics (+) irradiance scales, relative to the SIRREX-1 30 July 1992 scale transfer from F269.

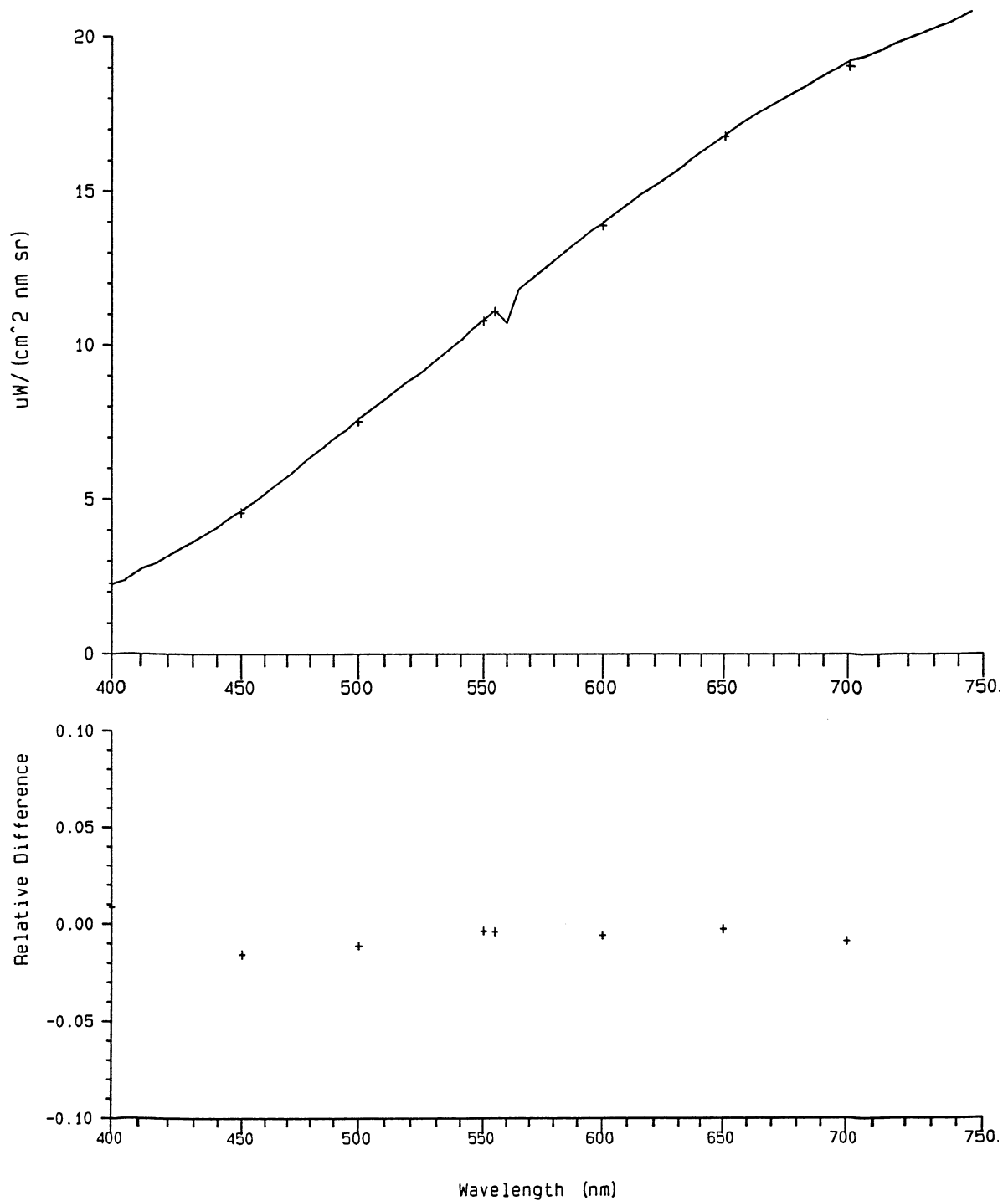

Fig. 4. Spectral irradiance of lamp F307 (top panel, solid line) using scale transfer from the NIST October 1992 F269 scale, during the SIRREX-1 lamp transfer on 30 July 1992, compared to the original calibration by Optronics (+). The bottom panel illustrates the differences between the Optronics irradiance scale (+) relative to that of SIRREX-1.

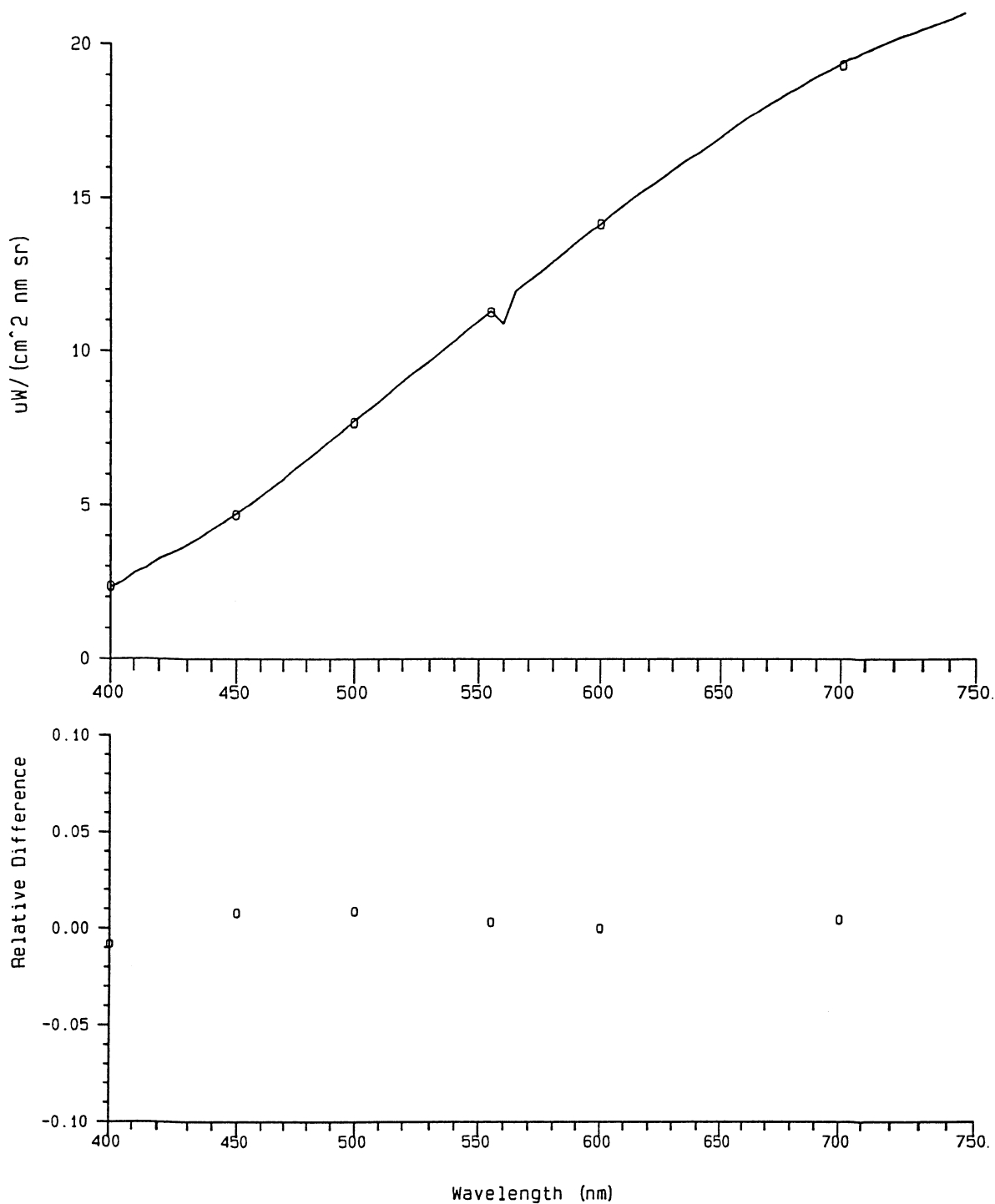

Fig. 5. Spectral irradiance of lamp F308 (top panel, solid line) using scale transfer from the NIST October 1992 F269 scale, during the SIRREX-1 lamp transfer on 30 July 1992, compared to the October 1992 calibration of F308 by NIST (O). The bottom panel illustrates the differences between the NIST irradiance scale (O) relative to that of SIRREX-1.

Table 3. Comparison of GSFC reference lamp (F269) transfer values for the beginning and ending of runs on 31 July 1992. (Irradiances, E , under each lamp column are in units of $\mu\text{W cm}^{-2} \text{ nm}^{-1}$.)

λ [nm]	E_{beg} 0805 PST	E_{end} 1430 PST	Ratio $E_{\text{end}}/E_{\text{beg}}$	λ [nm]	E_{beg} 0805 PST	E_{end} 1430 PST	Ratio $E_{\text{end}}/E_{\text{beg}}$
400	2.3662	2.3662	1.0000	580	12.6530	11.9714	0.9461
405	2.4454	2.5021	1.0232	585	12.9650	12.2896	0.9479
410	2.6910	2.6755	0.9942	590	13.3038	12.5947	0.9467
415	2.9352	2.9284	0.9977	595	13.5834	12.9072	0.9502
420	3.1330	3.0631	0.9777	600	13.9427	13.1813	0.9454
425	3.3767	3.3292	0.9859	605	14.2578	13.5572	0.9509
430	3.5978	3.5070	0.9748	610	14.5915	13.9306	0.9547
435	3.8256	3.7520	0.9807	615	14.9030	14.2362	0.9553
440	4.0572	3.9528	0.9743	620	15.2284	14.5725	0.9569
445	4.3393	4.2016	0.9683	625	15.5162	14.8352	0.9561
450	4.5939	4.4590	0.9706	630	15.7872	15.1161	0.9575
455	4.8476	4.7050	0.9706	635	16.1084	15.4151	0.9570
460	5.1562	4.9824	0.9663	640	16.3456	15.5436	0.9509
465	5.4143	5.2543	0.9705	645	16.5771	15.7698	0.9513
470	5.7236	5.5255	0.9654	650	16.8254	16.0274	0.9526
475	6.0094	5.8089	0.9666	655	17.0401	16.2841	0.9556
480	6.3134	6.0913	0.9648	660	17.3080	16.5479	0.9561
485	6.6291	6.3820	0.9627	665	17.5444	16.7816	0.9565
490	6.9383	6.6938	0.9648	670	17.7872	17.0176	0.9567
495	7.2886	7.0598	0.9686	675	18.0341	17.2637	0.9573
500	7.5700	7.3084	0.9654	680	18.2483	17.5105	0.9596
505	7.8808	7.5889	0.9630	685	18.4637	17.7143	0.9594
510	8.2117	7.8774	0.9593	690	18.5335	17.9483	0.9684
515	8.5418	8.1929	0.9592	695	18.7220	18.1879	0.9715
520	8.8715	8.4787	0.9557	700	18.8973	18.3855	0.9729
525	9.2131	8.8148	0.9568	705	19.1091	18.5781	0.9722
530	9.4998	9.0970	0.9576	710	19.2982	18.7540	0.9718
535	9.8233	9.3918	0.9561	715	19.4967	18.9379	0.9713
540	10.1550	9.7350	0.9586	720	19.6881	19.1006	0.9702
545	10.4325	9.9923	0.9578	725	19.8721	19.2678	0.9696
550	10.7656	10.2835	0.9552	730	20.0009	19.4342	0.9717
555	11.0584	10.5684	0.9557	735	20.1427	19.5562	0.9709
560	11.3529	10.8279	0.9538	740	20.3120	19.7386	0.9718
565	11.6450	11.1093	0.9540	745	20.4504	19.9090	0.9735
570	11.9960	11.4023	0.9505	750	20.5221	20.0441	0.9767
575	12.3173	11.6746	0.9478				

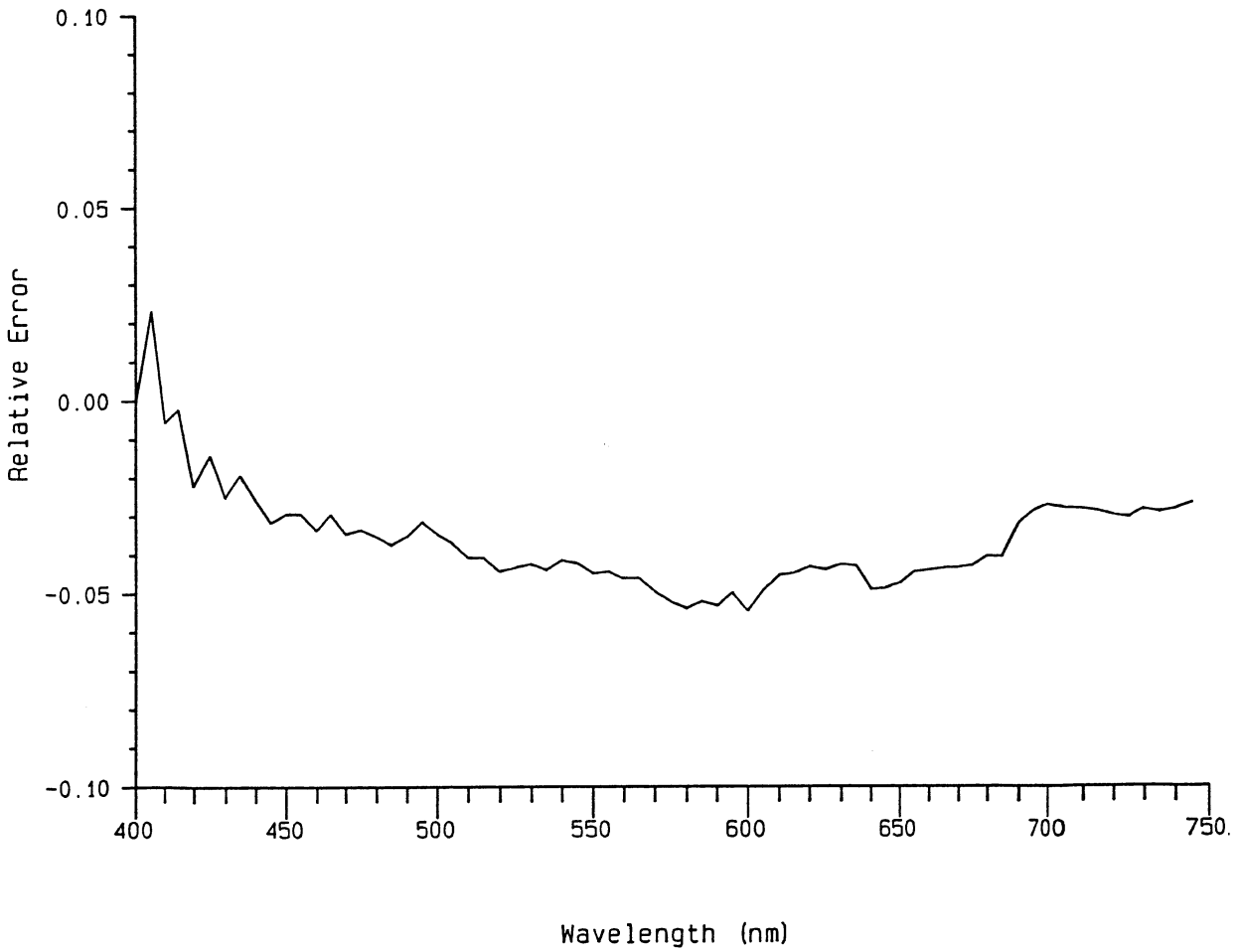

Fig. 6. Apparent drift in FEL lamp F269 between 0800 and 1430 PDT during the SIRREX-1 on 31 July 1992. F269 was the reference irradiance scale used during this transfer. The change is a clear symptom of drift in responsivity of the transfer radiometer during the comparisons.

Table 4. Irradiance scale transfer from GSFC lamp F269 on 31 July 1992 to lamps: F321, 91453, and F310 (all BSI). (Irradiances under each lamp column are in units of $\mu\text{W cm}^{-2} \text{nm}^{-1}$.)

λ [nm]	F321			91453		F310
	RR	BSI	NIST	RR	BSI	RR
400	1.9896	2.0541	2.0470	1.7438	1.8762	1.7918
405	2.1028	2.2280		1.9389	2.0369	2.0429
410	2.3927	2.4101		2.1003	2.2053	2.3048
415	2.5211	2.6002		2.3304	2.3812	2.3563
420	2.7584	2.7982		2.5073	2.5647	2.6648
425	2.9230	3.0040		2.6738	2.7556	2.8501
430	3.1666	3.2174		2.8678	2.9537	3.0565
435	3.3292	3.4383		3.0686	3.1588	3.2259
440	3.5876	3.6664		3.3062	3.3709	3.4665
445	3.8259	3.9014		3.5340	3.5897	3.7134
450	4.0583	4.1432	4.1420	3.7409	3.8150	3.9429
455	4.3354	4.3916		3.9941	4.0465	4.1977
460	4.8071	4.9066		4.4613	4.5272	4.6787
470	5.0824	5.1727		4.7255	4.7760	4.9431
475	5.3573	5.4442		4.9617	5.0298	5.1972
480	5.6333	5.7206		5.2316	5.2886	5.4649
485	5.9083	6.0018		5.4984	5.5520	5.7559
490	6.1934	6.2873		5.7537	5.8196	6.0312
495	6.4611	6.5768		6.0083	6.0912	6.3041
500	6.7659	6.8700	6.8940	6.3285	6.3665	6.6241
505	7.0583	7.1665		6.6071	6.6451	6.9133
510	7.3626	7.4660		6.8738	6.9267	7.2099
515	7.6353	7.7681		7.1517	7.2110	7.4741
520	7.9583	8.0726		7.4448	7.4976	7.8014
525	8.2519	8.3790		7.7362	7.7863	8.0707
530	8.5746	8.6870		8.0267	8.0768	8.3828
535	8.8991	8.9963		8.3362	8.3686	8.7115
540	9.1755	9.3066		8.5906	8.6616	8.9675
545	9.4643	9.6175		8.8854	8.9554	9.2756
550	9.7813	9.9288		9.1973	9.2496	9.5988
555	10.0860	10.2400	10.2800	9.4941	9.5441	9.8966
560	10.4097	10.5510		9.7795	9.8385	10.2230
565	10.7052	10.8614		10.0851	10.1326	10.5297
570	11.0020	11.1709		10.3788	10.4260	10.8222
575	11.3230	11.4792		10.6835	10.7185	11.1349
580	11.6220	11.7861		10.9837	11.0098	11.4358
585	11.9141	12.0913		11.2758	11.2998	11.7155
590	12.2319	12.3946		11.5641	11.5881	12.0346
595	12.5128	12.6957		11.8542	11.8745	12.3361

RR: Round-robin transfer on 31 July 1992.

NIST: Calibration by NIST on February 1991.

BSI: In-house transfer or interpolation at BSI.

Table 4. (cont.) Irradiance scale transfer from GSFC lamp F269 on 31 July 1992 to lamps: F321, 91453, and F310 (all BSI). (Irradiances under each lamp column are in units of $\mu\text{W cm}^{-2} \text{nm}^{-1}$.)

λ [nm]	F321			91453		F310
	RR	BSI	NIST	RR	BSI	RR
600	12.8162	12.9944	13.0300	12.1329	12.1588	12.6147
605	13.0896	13.2905		12.3865	12.4407	12.8852
610	13.3493	13.5837		12.6051	12.7202	13.1143
615	13.6397	13.8739		12.8841	12.9969	13.4107
620	13.9179	14.1608		13.1551	13.2706	13.6711
625	14.1923	14.4442		13.4116	13.5413	13.9345
630	14.4642	14.7241		13.6594	13.8088	14.1959
635	14.7236	15.0002		13.9061	14.0728	14.4606
640	15.0125	15.2724		14.2392	14.3332	14.7644
645	15.2670	15.5405		14.4823	14.5899	15.0232
650	15.4994	15.8044		14.7119	14.8428	15.2632
655	15.7510	16.0640		14.9367	15.0917	15.4956
660	15.9980	16.3191		15.1414	15.3365	15.7204
665	16.2203	16.5697		15.3539	15.5771	15.9393
670	16.4520	16.8156		15.5950	15.8134	16.1766
675	16.6913	17.0568		15.8199	16.0453	16.4284
680	16.9130	17.2931		16.0260	16.2728	16.6543
685	17.1481	17.5246		16.2640	16.4956	16.8778
690	17.3658	17.7511		16.4758	16.7139	17.0764
695	17.5562	17.9725		16.6726	16.9275	17.2760
700	17.8071	18.1889	18.1000	16.9114	17.1364	17.5133
705	17.9916	18.4001		17.0909	17.3404	17.6985
710	18.1775	18.6062		17.2633	17.5397	17.8776
715	18.3607	18.8071		17.4520	17.7340	18.0745
720	18.5455	19.0027		17.6695	17.9235	18.2583
725	18.7277	19.1932		17.8039	18.1081	18.4318
730	18.8855	19.3783		17.9485	18.2878	18.5877
735	19.0782	19.5582		18.1592	18.4625	18.7914
740	19.2381	19.7328		18.3072	18.6322	18.9551
745	19.3787	19.9022		18.4438	18.7970	19.1095
750	19.5145	20.0663		18.5849	18.9569	19.2222

RR: Round-robin transfer on 31 July 1992.

NIST: Calibration by NIST on February 1991.

BSI: In-house transfer or interpolation at BSI.

Table 5. Irradiance scale transfer from GSFC lamp F269 on 31 July 1992 to lamps: 90572, 91348, and 91534 (all CHORS). (Irradiances under each lamp column are in units of $\mu\text{W cm}^{-2} \text{ nm}^{-1}$.)

λ [nm]	90572		91348		91534	λ [nm]	90572		91348		91534
	RR	HEI	RR	CHORS	RR		RR	HEI	RR	CHORS	RR
400	0.7854	0.7416	1.6638	1.5670	2.0580	580	5.8775	6.0110	10.2523	10.1900	12.1804
405	0.8282	0.8162	1.8056	1.7160	2.2839	585	6.0705	6.2010	10.5241	10.4700	12.4814
410	0.9283	0.8946	2.0240	1.8720	2.5601	590	6.2525	6.3900	10.8053	10.7500	12.8086
415	1.0198	0.9749	2.1294	2.0340	2.7411	595	6.4572	6.5900	11.0832	11.0300	13.1071
420	1.0910	1.0620	2.3461	2.2040	2.9689	600	6.6578	6.7910	11.3270	11.3100	13.4032
425	1.1710	1.1530	2.4733	2.3810	3.1357	605	6.8351	6.9770	11.5934	11.5800	13.6946
430	1.2798	1.2510	2.6528	2.5650	3.3764	610	7.0115	7.1690	11.8373	11.8600	13.9604
435	1.3851	1.3510	2.8260	2.7550	3.5628	615	7.2053	7.3540	12.1055	12.1300	14.2808
440	1.4694	1.4550	3.0600	2.9520	3.8455	620	7.3815	7.5440	12.3549	12.3900	14.5536
445	1.5859	1.5660	3.2422	3.1560	4.0931	625	7.5564	7.7330	12.6088	12.6600	14.8330
450	1.6861	1.7210	3.4460	3.3660	4.3019	630	7.7360	7.9140	12.8619	12.9200	15.1094
455	1.8533	1.8410	3.6917	3.5810	4.5959	635	7.9199	8.1060	13.1098	13.1800	15.3777
460	1.9460	1.9650	3.9089	3.8030	4.8581	640	8.1117	8.2850	13.3785	13.4400	15.6544
465	2.0722	2.1060	4.1076	4.0300	5.1214	645	8.2887	8.4740	13.6214	13.6900	15.9221
470	2.2075	2.2370	4.3539	4.2620	5.3904	650	8.4585	8.7050	13.8613	13.9500	16.1925
475	2.3505	2.3760	4.5844	4.5000	5.6637	655	8.6379	8.8760	14.0825	14.1900	16.4456
480	2.4883	2.5010	4.8298	4.7430	5.9617	660	8.8040	9.0480	14.3006	14.4400	16.6880
485	2.6360	2.6770	5.0886	4.9900	6.2604	665	8.9610	9.2340	14.5187	14.6800	16.9306
490	2.7870	2.8280	5.3277	5.2410	6.5413	670	9.1366	9.4200	14.7456	14.9100	17.1713
495	2.9357	2.9810	5.5847	5.4970	6.8372	675	9.2997	9.5860	14.9636	15.1400	17.4124
500	3.0959	3.1460	5.8672	5.7560	7.1589	680	9.4618	9.7580	15.1685	15.3700	17.6374
505	3.2601	3.3030	6.0914	6.0190	7.4612	685	9.6298	9.9250	15.4019	15.5900	17.8787
510	3.4354	3.4680	6.3545	6.2860	7.7598	690	9.7900	10.1000	15.6075	15.8100	18.0966
515	3.5934	3.6420	6.6241	6.5550	8.0750	695	9.9490	10.2700	15.7891	16.0300	18.3033
520	3.7695	3.8110	6.9314	6.8270	8.3861	700	10.1182	10.4200	16.0228	16.2400	18.5524
525	3.9280	3.9930	7.1786	7.1010	8.6980	705	10.2646	10.5800	16.2046	16.4500	18.7350
530	4.1079	4.1630	7.4514	7.3770	9.0129	710	10.4137	10.7600	16.3776	16.6500	18.9132
535	4.2901	4.3450	7.7465	7.6550	9.3548	715	10.5613	10.9200	16.5575	16.8500	19.1049
540	4.4578	4.5200	7.9928	7.9350	9.6563	720	10.6979	11.0700	16.7433	17.0400	19.2993
545	4.6441	4.7060	8.2813	8.2160	9.9678	725	10.8541	11.2300	16.9091	17.2300	19.4855
550	4.7933	4.8890	8.5647	8.4970	10.2923	730	10.9826	11.3900	17.0696	17.4100	19.6554
555	4.9720	5.0760	8.8548	8.7800	10.6187	735	11.1308	11.5300	17.2476	17.5900	19.8354
560	5.1582	5.2580	9.1493	9.0630	10.9349	740	11.2688	11.6700	17.4059	17.7600	20.0053
565	5.3351	5.4480	9.4066	9.3450	11.2317	745	11.3834	11.8000	17.5388	17.9300	20.1491
570	5.5130	5.6390	9.6837	9.6280	11.5533	750	11.5153	11.9700	17.6778	18.1000	20.3092
575	5.7179	5.8240	9.9813	9.9110	11.8748						

RR: Round-robin transfer on 31 July 1992.
 CHORS: In-house transfer from lamp 90572.
 HEI: Original irradiance scale calibration by HEI.

Table 6. Irradiance scale transfer from GSFC lamp F269 on 31 July 1992 to lamps: F219 and F303 (UCSB), and to lamps F12G and F12H (UM). (Irradiances under each lamp column are in units of $\mu\text{W cm}^{-2} \text{ nm}^{-1}$.)

λ [nm]	F219		F303		F12G		F12H	
	RR	OI	RR	OI	RR	UM	RR	UM
400	2.2776	2.2500	2.2907	2.3100	2.0013	2.0670	2.0420	2.1310
405	2.4747		2.4478		2.1750		2.2594	
410	2.7721		2.7668		2.4521	2.4240	2.5209	2.5060
415	2.9085		2.9300		2.6462		2.6945	
420	3.2012		3.2230		2.9036	2.8190	2.9544	2.9050
425	3.3909		3.3848		3.0688		3.1418	
430	3.6804		3.6490		3.2872	3.2390	3.3921	3.3420
435	3.8818		3.8818		3.4999		3.5808	
440	4.1582		4.1660		3.7400	3.6950	3.8182	3.8090
445	4.4272		4.4413		3.9947		4.0791	
450	4.6866	4.5200	4.6641	4.6200	4.2218	4.1580	4.3115	4.2990
455	5.0031		4.9612		4.4881		4.6019	
460	5.2753		5.2501		4.7517	4.6590	4.8609	4.8040
465	5.5354		5.5196		5.0088		5.1136	
470	5.8353		5.8011		5.2877	5.2060	5.3758	5.3720
475	6.1370		6.1095		5.5516		5.6660	
480	6.4455		6.4088		5.8342	5.7610	5.9401	5.9220
485	6.7546		6.7217		6.1327		6.2419	
490	7.0788		7.0299		6.4202	6.3010	6.5452	6.4940
495	7.3392		7.3210		6.7057		6.8353	
500	7.7056	7.4400	7.6544	7.5800	7.0222	6.8750	7.1589	7.0770
505	8.0252		7.9930		7.3162		7.4451	
510	8.3708		8.3097		7.6223	7.4700	7.7445	7.6930
515	8.7051		8.6465		7.9137		8.0603	
520	9.0422		8.9709		8.2435	8.0840	8.3719	8.3050
525	9.3392		9.2834		8.5307		8.6701	
530	9.6978		9.6156		8.8485	8.6780	8.9992	8.9230
535	10.0517		9.9713		9.1806		9.3280	
540	10.3581		10.2802		9.4744	9.3040	9.6173	9.5520
545	10.6726		10.5970		9.7916		9.9174	
550	11.0344	10.7000	10.9492	10.8000	10.0976	9.9070	10.2436	10.1800
555	11.3645	11.0000	11.2816	11.2000	10.4174		10.5832	
560	11.7168		11.6234		10.7365	10.5500	10.8999	10.8300
565	12.0390		11.9337		11.0328		11.2083	
570	12.3683		12.2724		11.3496	11.1500	11.5054	11.4400
575	12.6898		12.6020		11.6616		11.8371	
580	13.0315		12.9118		11.9677	11.7600	12.1538	12.0800
585	13.3324		13.2331		12.2545		12.4247	
590	13.6888		13.5674		12.5657	12.3700	12.7327	12.6900
595	14.0066		13.8781		12.8822		13.0429	

RR: Round-robin transfer on 31 July 1992.

UM: In-house calibration at University of Miami.

OI: Original irradiance scale calibration by Optronics, Inc.

Table 6. (cont.) Irradiance scale transfer from GSFC lamp F269 on 31 July 1992 to lamps: F219 and F303 (UCSB), and to lamps F12G and F12H (UM). (Irradiances under each lamp column are in units of $\mu\text{W cm}^{-2} \text{nm}^{-1}$.)

λ [nm]	F219		F303		F12G		F12H	
	RR	OI	RR	OI	RR	UM	RR	UM
600	14.2617	13.8000	14.1565	14.1000	13.1666	12.8000	13.3331	13.3300
605	14.6022		14.4714		13.4330		13.6374	
610	14.8848		14.7438		13.7097	13.4600	13.9055	13.8600
615	15.2120		15.0518		14.0137		14.1969	
620	15.5034		15.3464		14.2918	14.0000	14.4788	14.3100
625	15.7831		15.6284		14.5531		14.7446	
630	16.0737		15.9070		14.8122	14.4800	15.0225	14.8000
635	16.3517		16.1811		15.0791		15.2853	
640	16.6465		16.4714		15.3845	15.0100	15.5669	15.3200
645	16.9277		16.7601		15.6479		15.8307	
650	17.1927	16.7000	17.0116	16.9000	15.8932	15.4900	16.0822	15.8000
655	17.4674		17.2679		16.1422		16.3338	
660	17.7033		17.5129		16.3707	15.9900	16.5690	16.3100
665	17.9376		17.7503		16.6028		16.7980	
670	18.1891		17.9901		16.8499	16.4700	17.0412	16.8000
675	18.4416		18.2312		17.0819		17.2772	
680	18.6723		18.4654		17.2900	16.9700	17.4970	17.3100
685	18.9162		18.7044		17.5353		17.7399	
690	19.1458		18.9360		17.7493	17.4200	17.9592	17.7500
695	19.3449		19.1294		17.9513		18.1596	
700	19.5914	19.1000	19.3836	19.3000	18.1726	17.8900	18.4019	18.2200
705	19.7857		19.5641		18.3633		18.5706	
710	19.9846		19.7560		18.5418		18.7704	
715	20.1853		19.9563		18.7399		18.9689	
720	20.3763		20.1394		18.9332		19.1414	
725	20.5608		20.3226		19.1030		19.3123	
730	20.7159		20.4617		19.2632		19.4811	
735	20.9161		20.6588		19.4458		19.6663	
740	21.0778		20.8246		19.6031		19.8191	
745	21.2186		20.9643		19.7527		19.9696	
750	21.3813	20.9000	21.1264	21.0000	19.9044		20.1218	

RR: Round-robin transfer on 31 July 1992.

UM: In-house calibration at University of Miami.

OI: Original irradiance scale calibration by Optronics, Inc.

Table 7. Irradiance scale transfer from GSFC lamp F269 on 31 July 1992 to lamps: F12L (SIO/MPL), F265 (NRaD), and S271 and S272 (Satlantic). (Irradiances under each lamp column are in units of $\mu\text{W cm}^{-2} \text{nm}^{-1}$.)

λ [nm]	F12L RR	F265 RR	S721 RR	S724 RR	λ [nm]	F12L RR	F265 RR	S721 RR	S724 RR
400	2.1438	2.3474	2.5220	2.4478	580	12.4464	13.2176	14.6272	14.1485
405	2.3744	2.6142	2.8295	2.5995	585	12.7509	13.5452	14.9493	14.4954
410	2.5994	2.8749	3.0762	2.9406	590	13.0666	13.8861	15.3581	14.9029
415	2.7799	3.0741	3.3304	3.0871	595	13.3641	14.1994	15.7093	15.2113
420	3.0488	3.4045	3.6077	3.3900	600	13.6572	14.5157	16.1276	15.5669
425	3.2633	3.5550	3.8588	3.5732	605	13.9645	14.8311	16.4581	15.9103
430	3.4865	3.8167	4.1156	3.8849	610	14.2424	15.1277	16.7415	16.2088
435	3.6662	4.0256	4.3266	4.0975	615	14.5327	15.4486	17.0821	16.5554
440	3.9432	4.3184	4.6545	4.4044	620	14.8303	15.7427	17.4105	16.8870
445	4.2022	4.5819	4.9652	4.7120	625	15.1129	16.0335	17.7422	17.2119
450	4.4365	4.8276	5.2379	4.9783	630	15.3705	16.3130	18.0603	17.5165
455	4.7306	5.1259	5.5690	5.2995	635	15.6550	16.6005	18.3850	17.8447
460	4.9953	5.4237	5.8829	5.5973	640	15.9389	16.8726	18.7036	18.1857
465	5.2498	5.7083	6.1981	5.9021	645	16.2116	17.1487	19.0228	18.4895
470	5.5322	6.0065	6.5125	6.2045	650	16.4603	17.4211	19.3034	18.7915
475	5.8214	6.3130	6.8549	6.5303	655	16.7250	17.7069	19.6389	19.0801
480	6.1129	6.6162	7.1950	6.8840	660	16.9577	17.9650	19.9082	19.3530
485	6.4210	6.9338	7.5722	7.2221	665	17.1960	18.2030	20.1778	19.6236
490	6.7192	7.2547	7.9153	7.5439	670	17.4315	18.4492	20.4923	19.9567
495	6.9741	7.5401	8.2156	7.8504	675	17.6904	18.7045	20.7477	20.1918
500	7.3127	7.9277	8.6282	8.2353	680	17.9183	18.9311	20.9934	20.4538
505	7.6385	8.2347	9.0244	8.6215	685	18.1637	19.1720	21.2981	20.7209
510	7.9736	8.5541	9.3789	8.9818	690	18.3716	19.3918	21.5481	20.9837
515	8.2655	8.8956	9.7456	9.3499	695	18.5834	19.6106	21.7872	21.2197
520	8.6001	9.2419	10.1261	9.7268	700	18.8175	19.8637	22.0636	21.5047
525	8.8931	9.5343	10.4822	10.0640	705	19.0066	20.0574	22.2947	21.7228
530	9.2321	9.9032	10.8620	10.4374	710	19.2061	20.2417	22.5059	21.9488
535	9.5826	10.2662	11.2579	10.8290	715	19.3839	20.4358	22.7326	22.1602
540	9.8773	10.5791	11.6188	11.1769	720	19.5722	20.6276	22.9467	22.3795
545	10.1691	10.9243	11.9689	11.5535	725	19.7597	20.8134	23.1660	22.6031
550	10.5112	11.2655	12.3848	11.9225	730	19.9315	20.9847	23.3236	22.7933
555	10.8436	11.6012	12.7613	12.3115	735	20.1074	21.1735	23.5555	23.0114
560	11.1799	11.9502	13.1405	12.6737	740	20.2809	21.3534	23.7442	23.2005
565	11.4891	12.2613	13.5015	13.0335	745	20.4183	21.4953	23.9186	23.3502
570	11.7930	12.5840	13.8784	13.4110	750	20.5791	21.6512	24.0952	23.5404
575	12.1381	12.9155	14.2572	13.7933					

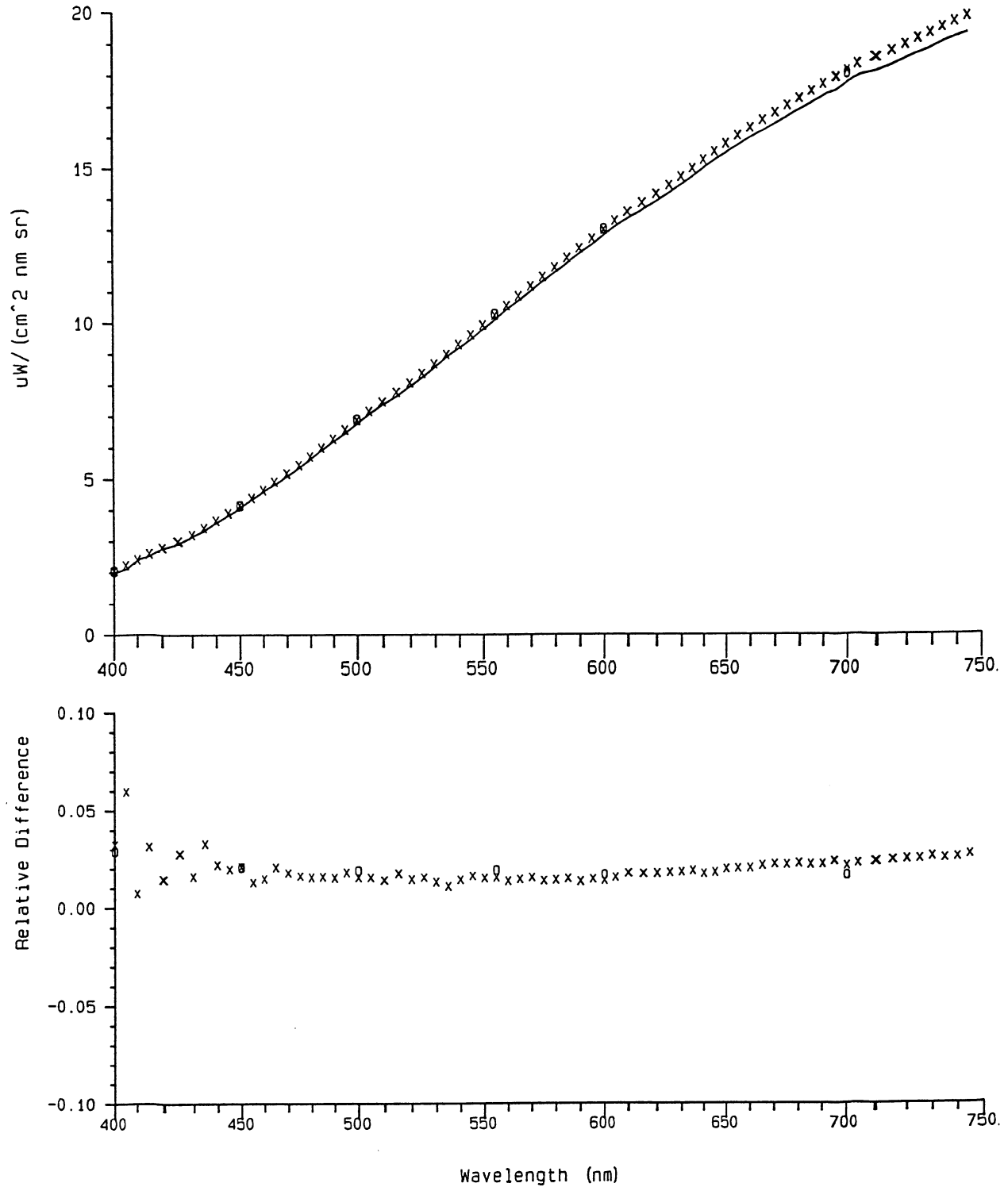

Fig. 7. Spectral irradiance of lamp F321 (top panel, solid line) using scale transfer from the NIST October 1992 F269 scale, during the SIRREX-1 lamp transfer on 31 July 1992, compared to the February 1991 calibration of F321 by NIST (0) and blackbody interpolation of the original NIST scale by BSI (x). The bottom panel illustrates the differences between the NIST (0) and BSI(x) scales relative to the SIRREX-1 31 July 1992 scale transfer from F269.

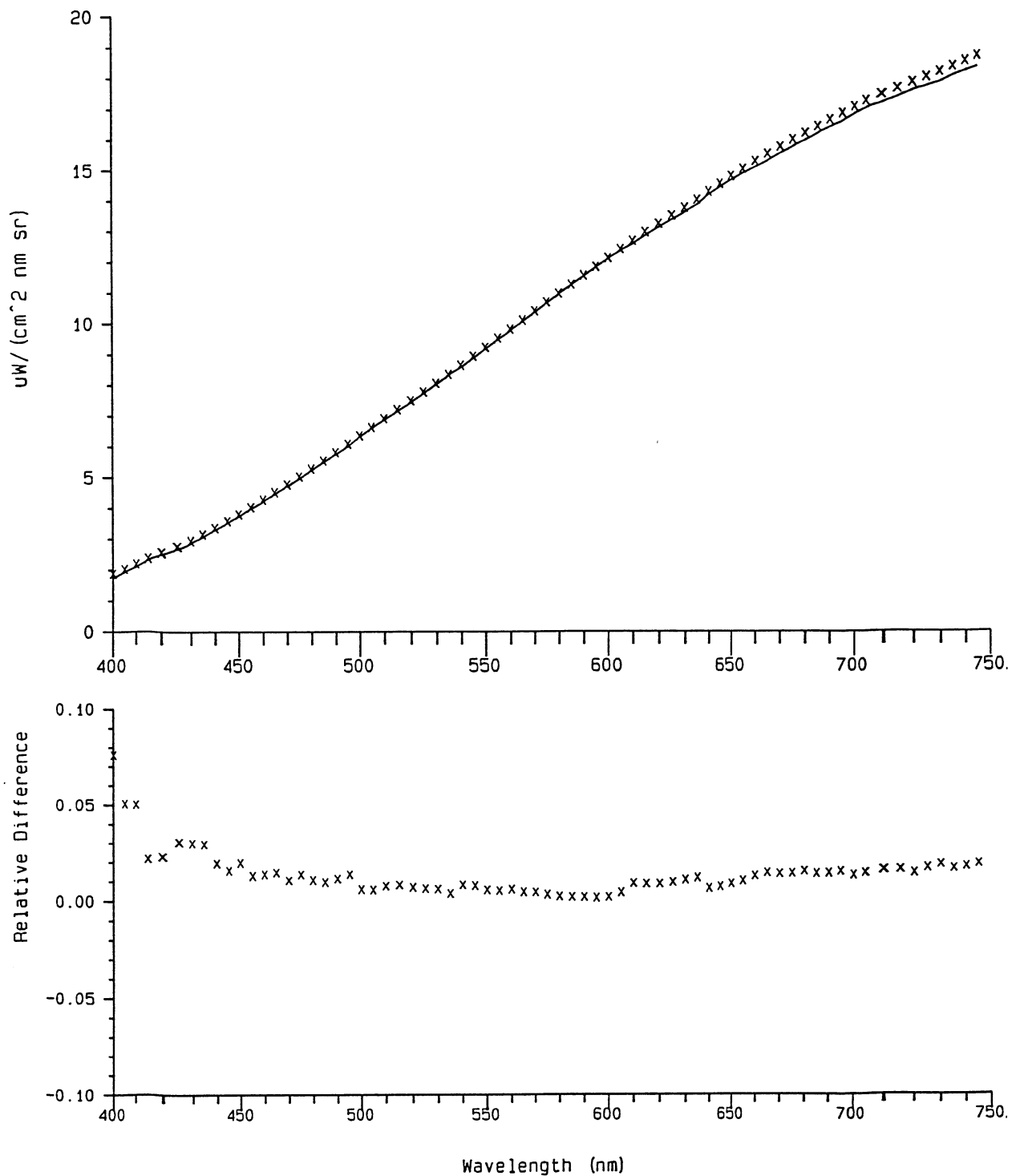

Fig. 8. Spectral irradiance of lamp 91453 (top panel, solid line) using scale transfer from the NIST October 1992 F269 scale, during the SIRREX-1 lamp transfer on 31 July 1992, compared to the in-house calibration of 91453 by BSI (x). The bottom panel illustrates the differences between the BSI (x) scale relative to the SIRREX-1 31 July 1992 scale transfer from F269.

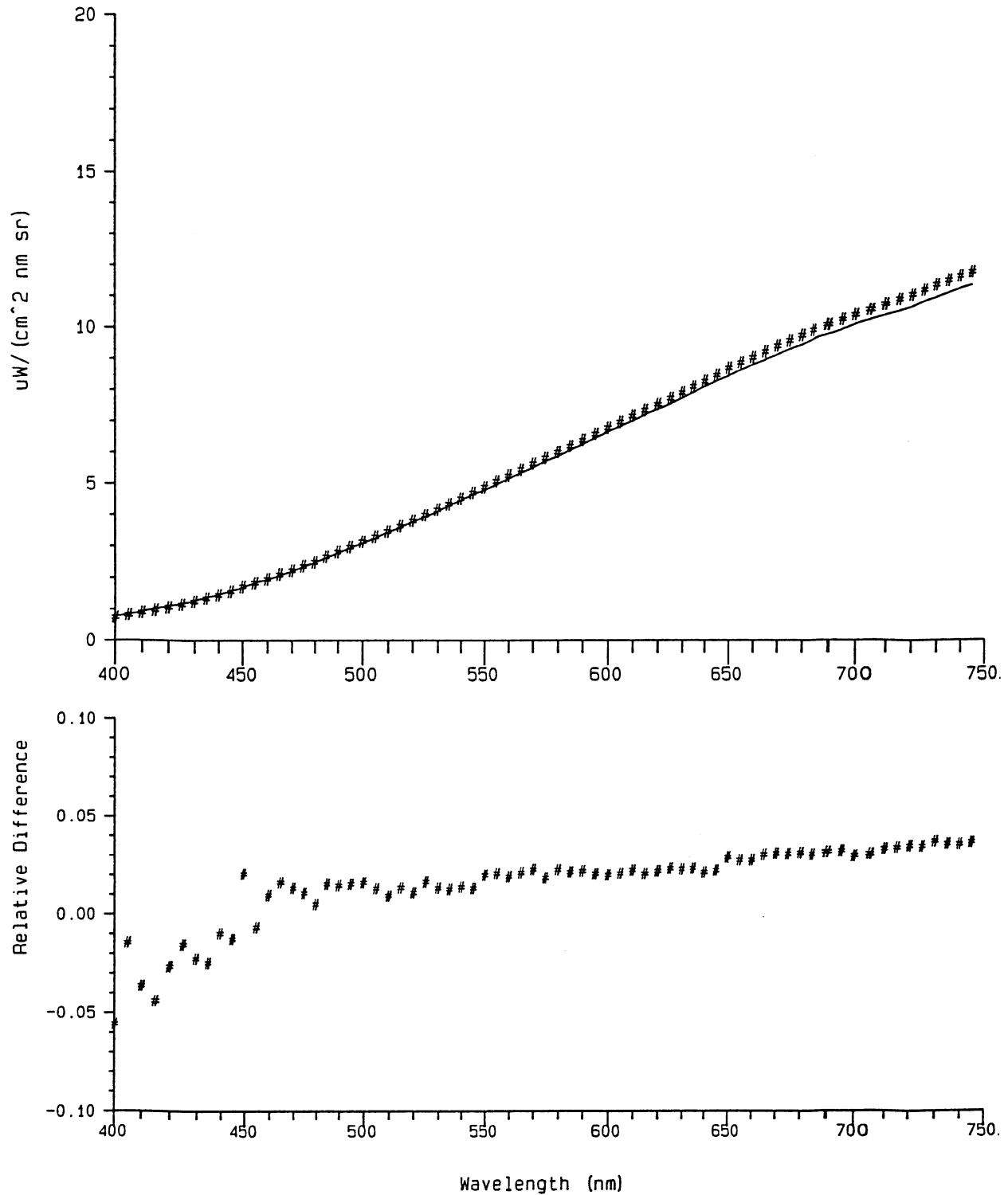

Fig. 9. Spectral irradiance of lamp 90572 (top panel, solid line) using scale transfer from the NIST October 1992 F269 scale, during the SIRREX-1 lamp transfer on 31 July 1992, compared to the original calibration by Hoffman Engineering, Inc., HEI (#). The bottom panel illustrates the differences between the HEI (#) scale relative to the SIRREX-1 31 July 1992 scale transfer from F269.

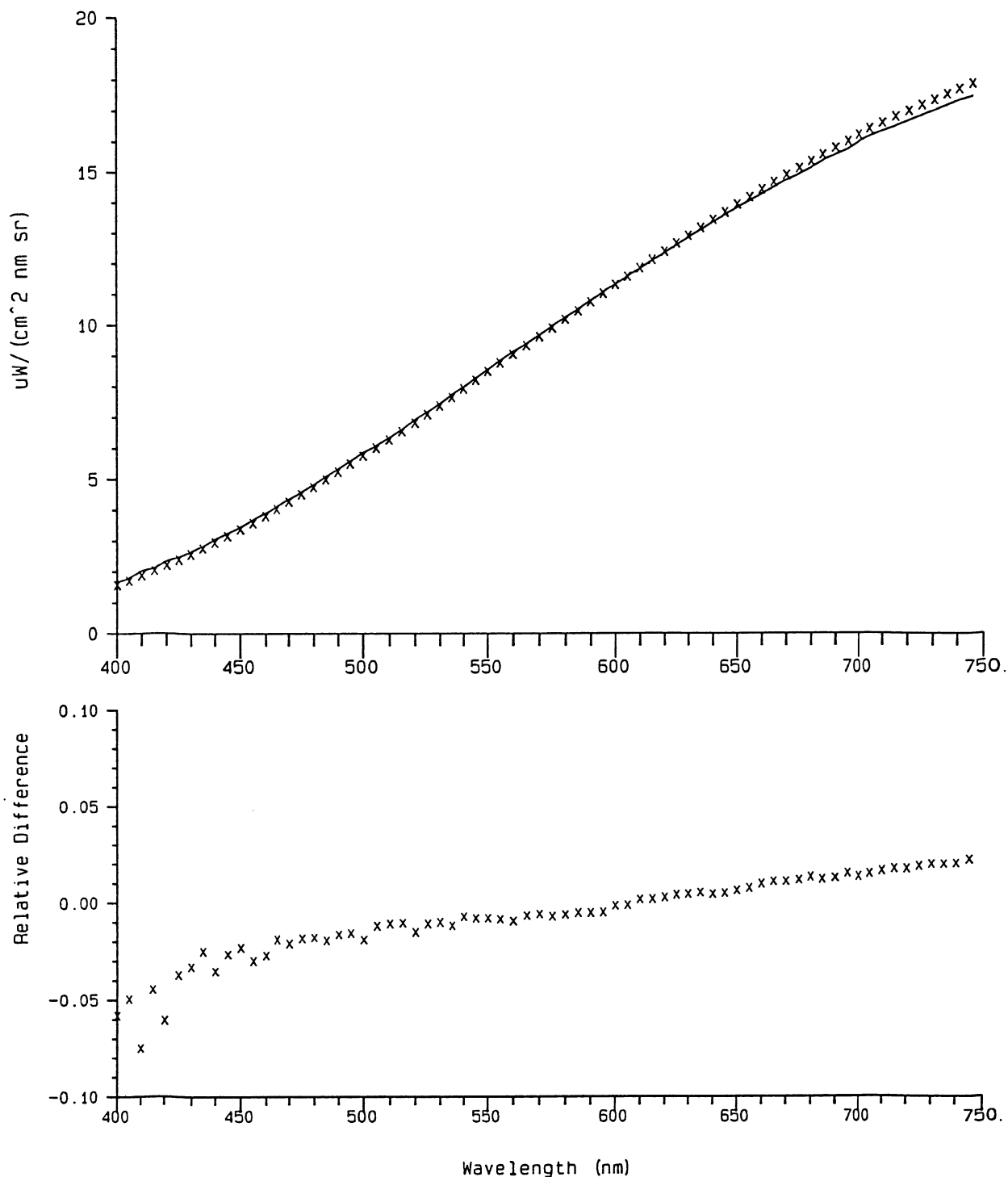

Fig. 10. Spectral irradiance of lamp 91348 (top panel, solid line) using scale transfer from the NIST October 1992 F269 scale, during the SIRREX-1 lamp transfer on 31 July 1992, compared to the in-house CHORS (\times) scale transfer from 90573. The bottom panel illustrates the differences between the CHORS (\times) scale relative to the SIRREX-1 31 July 1992 scale transfer from F269.

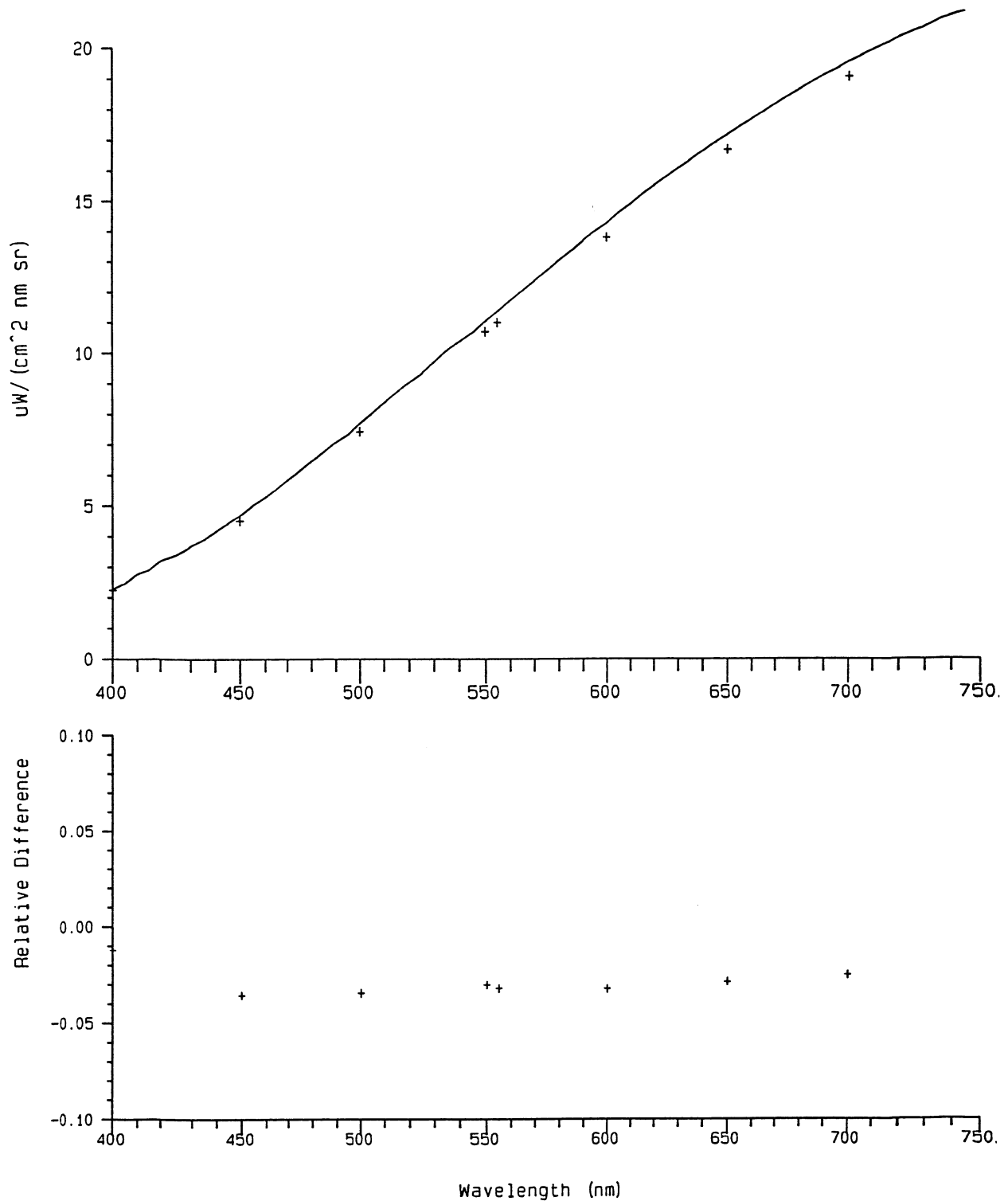

Fig. 11. Spectral irradiance of lamp F219 (top panel, solid line) using scale transfer from the NIST October 1992 F269 scale, during the SIRREX-1 lamp transfer on 31 July 1992, compared to the original calibration of F219 by Optronics (+). The bottom panel illustrates the differences between the Optronics (+) scale relative to the SIRREX-1 31 July 1992 scale transfer from F269.

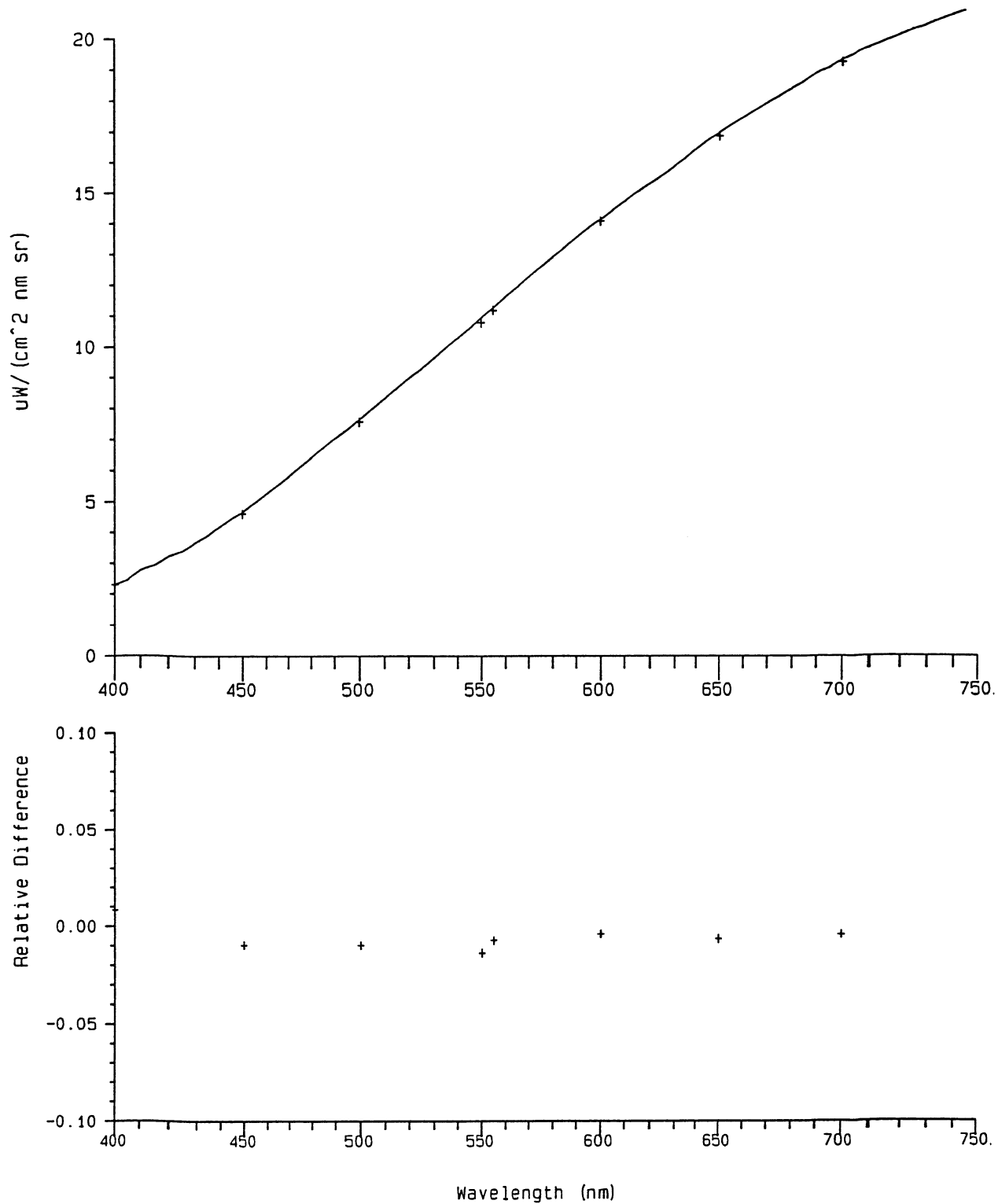

Fig. 12. Spectral irradiance of lamp F303 (top panel, solid line) using scale transfer from the NIST October 1992 F269 scale, during the SIRREX-1 lamp transfer on 31 July 1992, compared to the original calibration of F303 by Optronics (+). The bottom panel illustrates the differences between the Optronics (+) scale relative to the SIRREX-1 31 July 1992 scale transfer from F269.

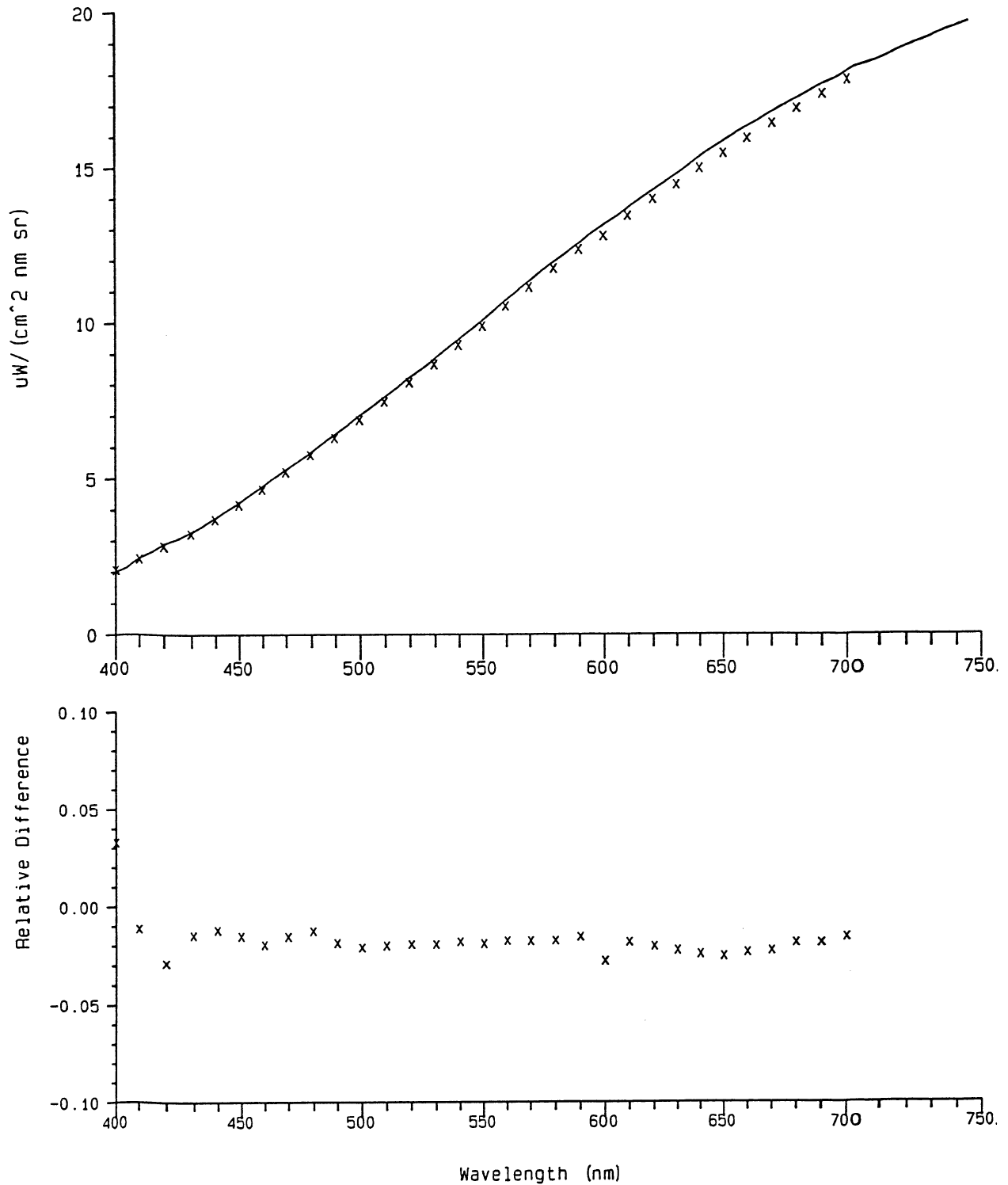

Fig. 13. Spectral irradiance of lamp F12G (top panel, solid line) using scale transfer from the NIST October 1992 F269 scale, during the SIRREX-1 lamp transfer on 31 July 1992, compared to the in-house calibration of F12G by UM (x). The bottom panel illustrates the differences between the UM (x) scale relative to the SIRREX-1 31 July 1992 scale transfer from F269.

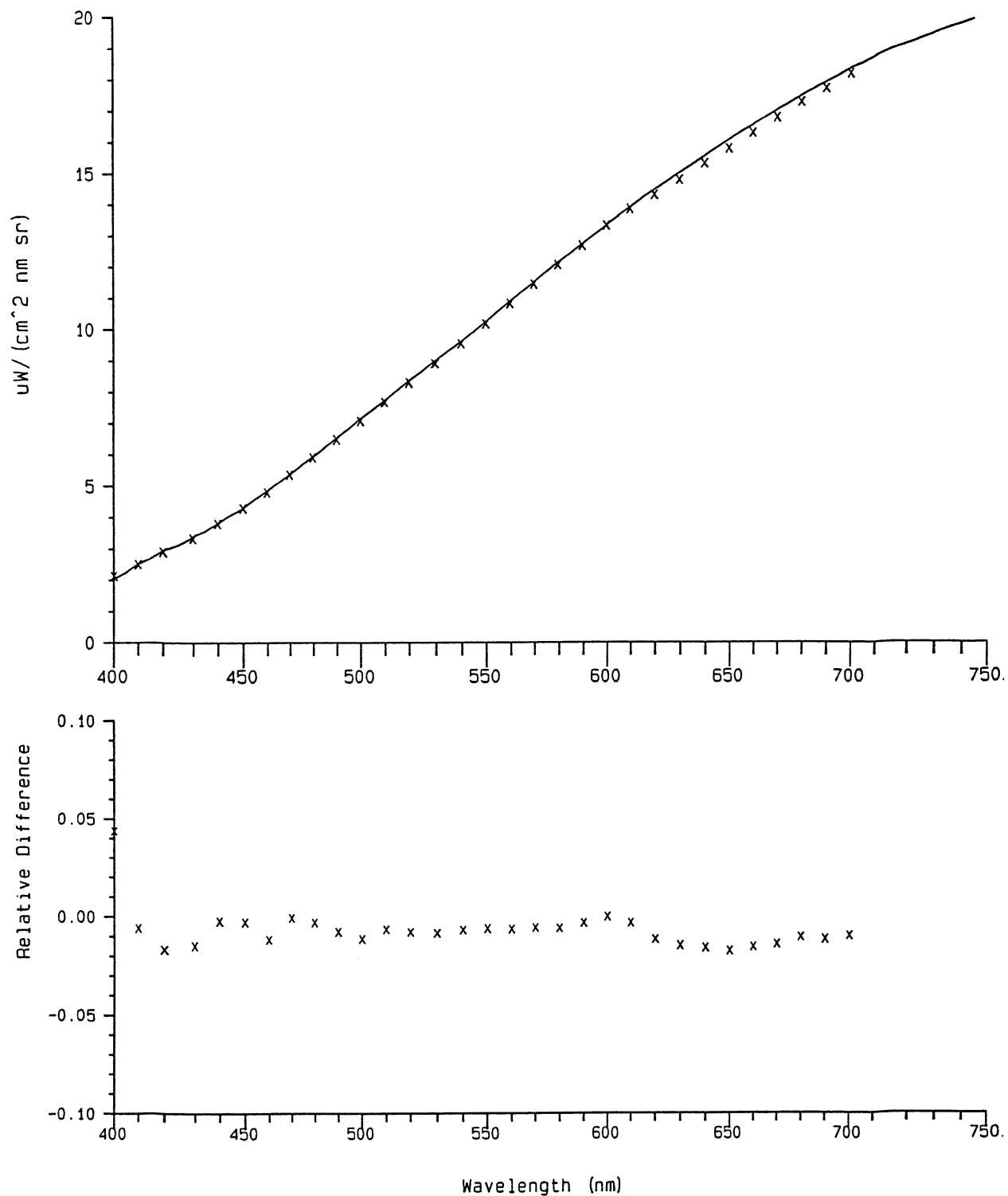

Fig. 14. Spectral irradiance of lamp F12H (top panel, solid line) using scale transfer from the NIST October 1992 F269 scale, during the SIRREX-1 lamp transfer on 31 July 1992, compared to the in-house calibration of F12H by UM (\times). The bottom panel illustrates the differences between the UM (\times) scale relative to the SIRREX-1 31 July 1992 scale transfer from F269.

F303, F12G, and F12H), and 7 (F12L, F265, S721, and S724). The results are illustrated in Figs. 7–14 for FEL lamps F321, 91453, 90572, 91348, F219, F303, F12G, and F12H, respectively. The currents (specified and measured) applied to these lamps during this transfer process are listed in Table 8.

Table 8. Lamp operating currents (in amps).

Lamp Number	Current Measured	Date of Measurement	Current Specified
F269	8.0009	30 July 1992	8.000
	8.0000	31 July 1992	
F268	8.0009	30 July 1992	8.000
F307	8.0009	30 July 1992	8.000
F308	8.0009	30 July 1992	8.000
F321	7.9005	31 July 1992	7.900
91453	7.9006	31 July 1992	7.900
F310	7.9007	31 July 1992	7.900
90572	7.1087	31 July 1992	7.108
91348	7.6565	31 July 1992	7.656
91534	8.0008	31 July 1992	8.000
F219	8.0007	31 July 1992	8.000
F303	8.0007	31 July 1992	8.000
F12G	8.0006	31 July 1992	8.000
F12H	7.9061	31 July 1992	7.906
F12L	7.8486	31 July 1992	7.849
F265	8.0000	31 July 1992	8.000
S271	8.0001	31 July 1992	8.000
S724	8.0002	31 July 1992	8.000

The irradiance scale transfers on 30 July 1992 from lamp F269 to lamps F269†, F268, F307, and F308 appear to have been accurate to within less than 1%, except near 400 nm. The outlier at 560 nm in all spectra (Figs. 2–5) obviously results from a single noise spike that occurred during the initial calibration of the 746/ISIC at the outset of the procedure; it should be edited out and filled in by interpolation when applying these tables. The conclusion about the accuracy of these transfers is based on the excellent agreement between the transferred F269 scales and those determined in independent calibrations of three of the four lamps by NIST in October 1992 (Figs. 2, 3, and 5). These results are clearly internally consistent and provide an acceptable basis for a common scale of spectral irradiance within this subset of working standard lamps (F269, F268, F307, and F308). This is mainly of benefit for lamp F307, since the other three were all recalibrated by NIST in October 1992, and are in excellent agreement with this transfer from F269.

The Optronics 746/ISIC transfer appears to have been much less stable and precise during the sessions of 31 July 1992. The instrument’s spectral irradiance responsivity appears to have drifted by as much as 5% between 0800

and 1430 PDT on that date (Fig. 6). Moreover, the comparison between the 31 July 1992 transfer of the F269 spectral irradiance scale to lamp F321 differs from its original NIST (February 1991) calibration by as much as 3% at 400 nm, although agreement is better at longer wavelengths (Fig. 7). It is possible that lamp F321 has decreased in brightness temperature through aging since its original calibration, but this particular session of scale transfers from lamp F269 was not sufficiently precise to support such a conclusion with any confidence. Many of the other lamps to which the F269 scale was transferred in the round-robin lamp transfer session of 31 July 1992 show similar, or larger, levels of disagreement (2–3%; Figs. 8–14), again with the largest discrepancies at wavelengths near 400 nm (as large as 5–6%).

Although it is possible that the erratic precision of irradiance scale transfers on 31 July 1992 may be at least partly due to responsivity drift in the Optronics 746 radiometer, subsequent stability tests of the instrument make it seem unlikely to have been the only error contributor (Section 3.5 below). It is also possible the lamp holder used during these tests may have allowed a partial short to the optical table, which would have caused the actual lamp currents to differ from those specified in Table 8. A kinematic lamp holder was borrowed from the Scripps Institution of Oceanography/Marine Physical Laboratory (SIO/MPL) for use during these tests, and it was necessary to mount it on posts compatible with the optical bench on which the 746/ISIC was mounted.

After SIRREX-1, the post SIO/MPL provided with the lamp holder was discovered to have been ground down to preclude any possibility of electrical contact with the lamp holder’s spring-loaded contacts, as there was no insulating material separating these components. When the holder was mounted on an unmodified post, the clearance between the post and the spring-loaded contacts was small enough (as was later discovered) that it was possible for them to come into contact when a lamp was pushed down into position. If this occurred during some or all of the lamp insertions during the 31 July 1992 transfers, current leaks to ground could easily account for many or all of the observed inconsistencies.

Whatever the actual source of errors may have been, the round-robin lamp irradiance scale transfers of 31 July 1992 do not achieve the 1% precision required for SeaWiFS validation intercalibrations. The resulting spectral irradiance scales in Tables 4–7 should be applied with skepticism, if at all.

3.2 Integrating Spheres

Integrating spheres are used as sources of spectral radiance for calibrating instruments at several of the participating laboratories. The spectral radiance levels of these spheres were all measured using the NIST PR714 spectral radiometer (Section 2.2). Based on post-calibration and

† An internal test of transfer precision.

Table 9. Comparison of NIST PR714 radiance measurements on GSFC sphere and factors $\bar{F}(\lambda)$ to convert the PR714 readings to match the radiance scale of the GSFC 42-inch sphere. At each wavelength (λ), radiance $L(\lambda)$ based on the GSFC sphere scale is calculated as $L(\lambda) = \bar{F}(\lambda)L_{714}(\lambda)$, where, $L_{714}(\lambda)$ is the PR714 radiance reading (P_i , $i = 1, 4$) multiplied by 100 to convert to units of $\mu\text{Wcm}^{-2} \text{nm}^{-1} \text{sr}^{-1}$. The $\bar{F}(\lambda)$ and σ values are computed from four data files: subscript 1 refers to SGD1NF01.SCN (28 July 1992), subscript 2 refers to SGD2NF01.SCN (28 July 1992), subscript 3 refers to SGD2NF02.SCN (28 July 1992), and subscript 4 refers to SGD3NF01.SCN (30 July 1992).

λ [nm]	GSFC	$\bar{F}(\lambda)$	σ	P_1	P_2	P_3	P_4	F_1	F_2	F_3	F_4	δ_1	δ_2	δ_3	δ_4
380	1.9010	1.0624	0.0103	1.7660	1.7880	1.7890	1.8150	1.0764	1.0632	1.0626	1.0474	0.0132	0.0007	0.0002	-0.0141
390	2.2690	1.0512	0.0183	2.1350	2.1390	2.1375	2.2255	1.0628	1.0608	1.0615	1.0195	0.0110	0.0092	0.0099	-0.0301
400	2.8410	1.0483	0.0147	2.7000	2.6890	2.6780	2.7760	1.0522	1.0565	1.0609	1.0234	0.0038	0.0079	0.0120	-0.0237
410	3.4690	1.0476	0.0118	3.3070	3.2860	3.2795	3.3750	1.0490	1.0557	1.0578	1.0279	0.0013	0.0077	0.0097	-0.0188
420	4.2370	1.0344	0.0107	4.0900	4.0670	4.0610	4.1680	1.0359	1.0418	1.0433	1.0166	0.0015	0.0071	0.0086	-0.0173
430	5.0050	1.0372	0.0106	4.8235	4.7915	4.7815	4.9080	1.0376	1.0446	1.0467	1.0198	0.0004	0.0071	0.0092	-0.0168
440	5.8790	1.0130	0.0102	5.8110	5.7560	5.7520	5.8980	1.0117	1.0214	1.0221	0.9968	-0.0013	0.0083	0.0090	-0.0160
450	6.8270	1.0352	0.0101	6.6090	6.5430	6.5345	6.6960	1.0330	1.0434	1.0448	1.0196	-0.0021	0.0079	0.0093	-0.0151
460	7.7740	1.0300	0.0104	7.5690	7.4830	7.4770	7.6650	1.0271	1.0389	1.0397	1.0142	-0.0028	0.0087	0.0095	-0.0153
470	8.7870	1.0203	0.0102	8.6405	8.5435	8.5265	8.7430	1.0170	1.0285	1.0306	1.0050	-0.0032	0.0081	0.0101	-0.0149
480	9.8930	1.0480	0.0104	9.4720	9.3620	9.3490	9.5820	1.0444	1.0567	1.0582	1.0325	-0.0033	0.0084	0.0098	-0.0148
490	11.0730	1.0263	0.0106	10.8400	10.6950	10.6750	10.9500	1.0215	1.0353	1.0373	1.0112	-0.0047	0.0088	0.0107	-0.0147
500	12.2460	1.0342	0.0109	11.9000	11.7400	11.7100	12.0200	1.0291	1.0431	1.0458	1.0188	-0.0049	0.0086	0.0112	-0.0149
510	13.3900	1.0368	0.0107	12.9800	12.8000	12.7800	13.1050	1.0316	1.0461	1.0477	1.0217	-0.0050	0.0090	0.0106	-0.0145
520	14.6420	1.0294	0.0107	14.3000	14.1000	14.0700	14.4300	1.0239	1.0384	1.0407	1.0147	-0.0054	0.0088	0.0109	-0.0143
530	15.9330	1.0394	0.0111	15.4150	15.1850	15.1650	15.5600	1.0336	1.0493	1.0506	1.0240	-0.0055	0.0095	0.0108	-0.0148
540	17.1720	1.0494	0.0112	16.4500	16.2100	16.1900	16.6100	1.0439	1.0593	1.0607	1.0338	-0.0053	0.0094	0.0107	-0.0149
550	18.3800	1.0274	0.0111	18.0000	17.7200	17.6900	18.1550	1.0211	1.0372	1.0390	1.0124	-0.0062	0.0095	0.0113	-0.0146
560	19.5950	1.0262	0.0113	19.2200	18.9100	18.8800	19.3800	1.0195	1.0362	1.0379	1.0111	-0.0065	0.0098	0.0114	-0.0147
570	20.8470	1.0390	0.0117	20.1900	19.8700	19.8300	20.3750	1.0325	1.0492	1.0513	1.0232	-0.0063	0.0097	0.0118	-0.0153
580	22.1680	1.0399	0.0117	21.4500	21.1100	21.0700	21.6500	1.0335	1.0501	1.0521	1.0239	-0.0062	0.0098	0.0117	-0.0154
590	23.4590	1.0249	0.0120	23.0450	22.6600	22.6100	23.2550	1.0180	1.0353	1.0375	1.0088	-0.0068	0.0101	0.0124	-0.0157
600	24.7150	1.0298	0.0122	24.1600	23.7600	23.7000	24.3900	1.0230	1.0402	1.0428	1.0133	-0.0067	0.0101	0.0126	-0.0160
610	26.1110	1.0506	0.0122	25.0200	24.6000	24.5600	25.2500	1.0436	1.0614	1.0632	1.0341	-0.0066	0.0103	0.0120	-0.0157
620	27.4070	1.0595	0.0127	26.0400	25.6000	25.5500	26.3000	1.0525	1.0706	1.0727	1.0421	-0.0066	0.0105	0.0125	-0.0164
630	28.6470	1.0518	0.0127	27.4300	26.9500	26.9000	27.6850	1.0444	1.0630	1.0649	1.0347	-0.0070	0.0107	0.0125	-0.0162
640	29.7750	1.0454	0.0128	28.6800	28.1700	28.1300	28.9600	1.0382	1.0570	1.0585	1.0281	-0.0069	0.0110	0.0125	-0.0165

Table 9. (cont.) Comparison of NIST PR714 radiance measurements on GSFC sphere and factors $\bar{F}(\lambda)$ to convert the PR714 readings to match the radiance scale of the GSFC 42-inch sphere. At each wavelength (λ), radiance $L(\lambda)$ based on the GSFC sphere scale is calculated as $L(\lambda) = \bar{F}(\lambda)L_{714}(\lambda)$, where, $L_{714}(\lambda)$ is the PR714 radiance reading ($P_i, i = 1,4$) multiplied by 100 to convert to units of $\mu\text{Wcm}^{-2} \text{nm}^{-1} \text{sr}^{-1}$. The $\bar{F}(\lambda)$ and σ values are computed from four data files: subscript 1 refers to SGD1NF01.SCN (28 July 1992), subscript 2 refers to SGD2NF01.SCN (28 July 1992), subscript 3 refers to SGD2NF02.SCN (28 July 1992), and subscript 4 refers to SGD3NF01.SCN (30 July 1992),

λ [nm]	GSFC	$\bar{F}(\lambda)$	σ	P_1	P_2	P_3	P_4	F_1	F_2	F_3	F_4	δ_1	δ_2	δ_3	δ_4
650	30.8680	1.0509	0.0129	29.5650	29.0600	29.0100	29.8800	1.0441	1.0622	1.0640	1.0331	-0.0064	0.0108	0.0126	-0.0169
660	31.8470	1.0527	0.0128	30.4600	29.9300	29.8800	30.7600	1.0455	1.0640	1.0658	1.0353	-0.0068	0.0108	0.0125	-0.0165
670	32.8740	1.0496	0.0131	31.5350	30.9750	30.9250	31.8650	1.0425	1.0613	1.0630	1.0317	-0.0068	0.0111	0.0128	-0.0171
680	33.9470	1.0431	0.0129	32.7700	32.1900	32.1400	33.1000	1.0359	1.0546	1.0562	1.0256	-0.0069	0.0110	0.0126	-0.0168
690	35.0290	1.0495	0.0128	33.5900	33.0250	32.9600	33.9500	1.0428	1.0607	1.0628	1.0318	-0.0064	0.0106	0.0126	-0.0169
700	36.1140	1.0689	0.0129	34.0000	33.4400	33.3700	34.3600	1.0622	1.0800	1.0822	1.0510	-0.0062	0.0104	0.0125	-0.0167
710	37.0000	1.0827	0.0131	34.3750	33.8300	33.7500	34.7650	1.0764	1.0937	1.0963	1.0643	-0.0058	0.0102	0.0126	-0.0170
720	37.8370	1.0847	0.0132	35.0700	34.5200	34.4600	35.5000	1.0789	1.0961	1.0980	1.0658	-0.0054	0.0105	0.0123	-0.0174
730	38.7040	1.0719	0.0132	36.3050	35.7350	35.6600	36.7600	1.0661	1.0831	1.0854	1.0529	-0.0054	0.0105	0.0126	-0.0177
740	39.5270	1.0552	0.0133	37.6800	37.0600	36.9800	38.1400	1.0490	1.0666	1.0689	1.0364	-0.0059	0.0108	0.0130	-0.0179
750	40.2120	1.0533	0.0136	38.4000	37.7600	37.6850	38.8900	1.0472	1.0649	1.0671	1.0340	-0.0058	0.0111	0.0131	-0.0183
760	40.5920	1.0574	0.0137	38.5800	37.9800	37.8900	39.1300	1.0522	1.0688	1.0713	1.0374	-0.0050	0.0108	0.0132	-0.0189
770	41.6100	1.0658	0.0139	39.2500	38.6150	38.5300	39.7900	1.0601	1.0776	1.0799	1.0457	-0.0054	0.0110	0.0132	-0.0189
780	42.2200	1.0750	0.0143	39.4800	38.8400	38.7500	40.0500	1.0694	1.0870	1.0895	1.0542	-0.0052	0.0111	0.0135	-0.0194
790	42.7370	1.0830	0.0146	39.6650	39.0250	38.9250	40.2550	1.0774	1.0951	1.0979	1.0617	-0.0052	0.0112	0.0138	-0.0197
800	43.2280	1.0880	0.0150	39.9400	39.2800	39.1900	40.5500	1.0823	1.1005	1.1030	1.0660	-0.0052	0.0115	0.0138	-0.0202
810	43.6590	1.0807	0.0152	40.6150	39.9350	39.8250	41.2450	1.0749	1.0933	1.0963	1.0585	-0.0054	0.0116	0.0144	-0.0206
820	43.9980	1.0779	0.0154	41.0300	40.3400	40.2400	41.7000	1.0723	1.0907	1.0934	1.0551	-0.0051	0.0119	0.0144	-0.0211
830	44.3470	1.0787	0.0157	41.3200	40.6250	40.5150	42.0150	1.0733	1.0916	1.0946	1.0555	-0.0051	0.0119	0.0147	-0.0215
840	44.8020	1.0920	0.0164	41.2600	40.5200	40.4200	41.9500	1.0858	1.1057	1.1084	1.0680	-0.0056	0.0125	0.0150	-0.0220
850	44.9920	1.1034	0.0167	41.0100	40.2700	40.1600	41.7000	1.0971	1.1173	1.1203	1.0789	-0.0057	0.0126	0.0153	-0.0222
860	45.2160	1.1155	0.0171	40.7400	40.0300	39.9200	41.4800	1.1099	1.1296	1.1327	1.0901	-0.0051	0.0126	0.0154	-0.0228
870	45.4090	1.1110	0.0174	41.1050	40.3500	40.2350	41.8400	1.1047	1.1254	1.1286	1.0853	-0.0057	0.0129	0.0158	-0.0231
880	45.4740	1.1046	0.0175	41.4000	40.6400	40.5200	42.1500	1.0984	1.1189	1.1223	1.0789	-0.0056	0.0130	0.0160	-0.0233
890	45.6290	1.0993	0.0178	41.7450	40.9600	40.8450	42.5250	1.0930	1.1140	1.1171	1.0730	-0.0057	0.0134	0.0162	-0.0239
900	45.4860	1.0932	0.0179	41.8300	41.0500	40.9500	42.6500	1.0874	1.1081	1.1108	1.0665	-0.0053	0.0136	0.0161	-0.0244

analyses of the PR714's radiance responsivity at NIST, it was decided the best approach would be to base the interpretation of the SIRREX-1 radiance source intercomparisons on the radiance scale of the GSFC 42-inch sphere.

The PR714 measured the spectral radiance of the GSFC sphere (16 lamps at 6.5 A) in three trials on 28 July 1992 and one on 30 July 1992. The GSFC sphere radiance scale and the PR714 readings from the four trials are listed in Table 9 at 10 nm intervals. The conversion factors, $F(\lambda)$, required to adjust the PR714 readings to match the GSFC scale are also listed in Table 9, together with the mean and standard deviations from the four trials, and the departure δ of each individual conversion factor from the mean. The mean and individual scale factors $F(\lambda)$, to convert PR714 readings to the GSFC sphere radiance scale, are illustrated in Fig. 15.

Table 10 lists the mean scale factors $\bar{F}(\lambda)$, including the units conversion factor of 100, at the 4 nm wavelength intervals measured by the PR714. This table may be used directly to convert PR714 data files to the GSFC sphere radiance scale.

Radiance spectra were also measured with the PR714 (GSFC scale) for the spheres belonging to CHORS (40-inch sphere illuminated through four 12-inch auxiliary spheres), NOAA (Optronics 420M source), BSI (20-inch sphere with one internal lamp), and UCSB (20-inch sphere illuminated through an entrance port by FEL lamp F303 at a distance of 50 cm). The spectral radiances measured during all trials for each of these spheres are listed, at 4 nm intervals, in Tables 11–14, respectively. The maximum spectral radiance output of each sphere is illustrated in Fig. 16, and representative ranges of radiance for spheres with variable illumination schemes (not including the GSFC sphere) are illustrated in Fig. 17.

NIST personnel (C. Johnson and C. Cromer) also measured the spectral radiance emission from several of the spheres using well-calibrated, broad-band, filtered photodetectors. The results of these measurements are given in Appendix A. In summary, the measured photodetector currents were consistent with values predicted by integrating the radiance spectra measured with the PR714, weighted by the spectral response functions of the two photodetectors. For the GSFC sphere, agreement was within less than 1%, and less than 3% for the BSI 20-inch sphere. The PR714 and photodetector measurements of the CHORS 40-inch sphere were made with different sphere illumination setups; the predicted and measured photodetector currents differed by 30%.

The flux emitted by NOAA's Optronics 420M was too low to be accurately measured with the photodetectors. With careful and systematic setups, these broad-band irradiance measurements can provide a valuable test of radiance scale transfer precision, e.g., with the PR714, and they should be included in future SIRREXs.

Table 10. PR714 conversion to GSFC sphere radiance scales at PR714 wavelengths. (Includes a factor of 100 for units conversion.)

λ [nm]	$\bar{F}(\lambda)$	λ [nm]	$\bar{F}(\lambda)$	λ [nm]	$\bar{F}(\lambda)$
380	106.241	556	102.668	732	106.852
384	105.791	560	102.617	736	106.186
388	105.340	564	103.132	740	105.521
392	105.057	568	103.647	744	105.444
396	104.942	572	103.921	748	105.368
400	104.826	576	103.956	752	105.411
404	104.799	580	103.991	756	105.576
408	104.771	584	103.390	760	105.740
412	104.494	588	102.789	764	106.078
416	103.968	592	102.588	768	106.415
420	103.441	596	102.785	772	106.768
424	103.551	600	102.983	776	107.136
428	103.662	604	103.813	780	107.504
432	103.233	608	104.642	784	107.824
436	102.266	612	105.235	788	108.144
440	101.298	616	105.591	792	108.403
444	102.186	620	105.946	796	108.600
448	103.074	624	105.638	800	108.798
452	103.414	628	105.330	804	108.509
456	103.206	632	105.049	808	108.220
460	102.998	636	104.797	812	108.018
464	102.609	640	104.544	816	107.903
468	102.220	644	104.761	820	107.788
472	102.580	648	104.977	824	107.822
476	103.688	652	105.122	828	107.857
480	104.795	656	105.195	832	108.139
484	103.931	660	105.269	836	108.668
488	103.066	664	105.146	840	109.198
492	102.791	668	105.023	844	109.655
496	103.105	672	104.831	848	110.112
500	103.419	676	104.569	852	110.583
504	103.523	680	104.308	856	111.069
508	103.627	684	104.565	860	111.554
512	103.532	688	104.823	864	111.372
516	103.237	692	105.339	868	111.190
520	102.943	696	106.112	872	110.972
524	103.340	700	106.885	876	110.717
528	103.738	704	107.438	880	110.462
532	104.138	708	107.990	884	110.249
536	104.541	712	108.307	888	110.035
540	104.943	716	108.389	892	109.807
544	104.063	720	108.470	896	109.562
548	103.184	724	107.956	900	109.318
552	102.719	728	107.442		

3.3 Reflectance Plaque Intercomparisons

The reflectances of four Spectralon reflectance plaques, which were all manufactured by Labsphere, Inc., were compared on 3 July 1992. Each plaque was mounted on a photometric bar and illuminated at normal incidence by

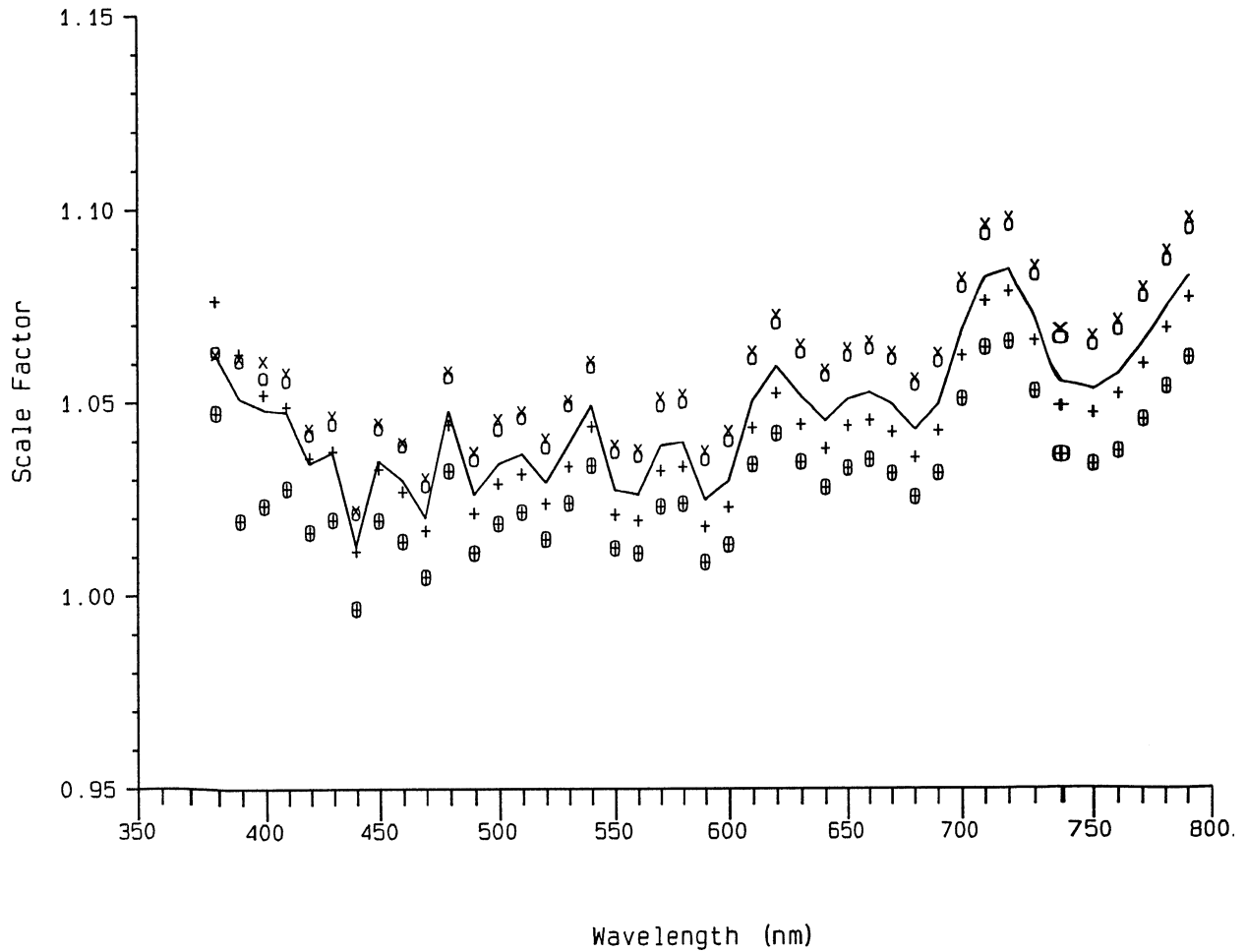

Fig. 15. Scale factors to adjust radiance measurements with the NIST PR714 spectroradiometer to the spectral radiance scale of the GSFC 42-inch integrating sphere source (Table 9). The solid line illustrates the average of four independent PR714 measurements of the spectral radiance output from the GSFC sphere during SIRREX-1 and the points are the scale factors for each individual spectral measurement on 28 July 1992 (+, \times , and \oplus) and 30 July 1992 (\otimes).

Table 11. Radiance outputs of CHORS 40-inch integrating sphere, measured with the NIST PR714 radiometer, and calibrated to the radiance scale of the GSFC sphere. (Radiances, $L_i(\lambda)$, are in units of $\mu\text{W cm}^{-2} \text{ nm}^{-1} \text{ sr}^{-1}$.)

Run	File	Date	Lamp Aperture Diameters [in.]
1	SCH3NF01.SCN	28 July 1992	1.250–1.250–1.250–1.250
2	SCH3NF02.SCN	28 July 1992	0.312–0.312–0.438–0.438
3	SCH3NF03.SCN	30 July 1992	1.250–1.250–1.250–1.250
4	S_CHOR1.SCN	29 July 1992	1.250–1.250–1.250–1.250
5	S_CHOR2.SCN	29 July 1992	0.875–0.875–1.080–1.080
6	S_CHOR3.SCN	29 July 1992	0.628–0.628–0.766–0.766
7	S_CHOR4.SCN	29 July 1992	0.438–0.438–0.531–0.531
8	S_CHOR5.SCN	29 July 1992	0.312–0.312–0.438–0.438
9	S_CHOR6.SCN	29 July 1992	0.000–0.312–0.000–0.438
10	S_CHOR7.SCN	29 July 1992	0.312–0.000–0.438–0.000

λ [nm]	$L_1(\lambda)$	$L_2(\lambda)$	$L_3(\lambda)$	$L_4(\lambda)$	$L_5(\lambda)$	$L_6(\lambda)$	$L_7(\lambda)$	$L_8(\lambda)$	$L_9(\lambda)$	$L_{10}(\lambda)$
380	0.699	0.052	0.773	0.820	0.522	0.242	0.102	0.057	0.031	0.024
384	0.814	0.058	0.874	0.928	0.586	0.267	0.113	0.063	0.035	0.027
388	0.974	0.068	1.033	1.085	0.693	0.314	0.132	0.073	0.041	0.032
392	1.140	0.079	1.193	1.256	0.806	0.369	0.154	0.086	0.048	0.037
396	1.326	0.093	1.387	1.462	0.935	0.434	0.182	0.101	0.056	0.044
400	1.537	0.107	1.564	1.651	1.063	0.496	0.209	0.116	0.065	0.050
404	1.743	0.123	1.746	1.844	1.195	0.562	0.241	0.134	0.075	0.058
408	1.939	0.141	1.931	2.042	1.328	0.631	0.273	0.153	0.085	0.067
412	2.112	0.155	2.105	2.224	1.451	0.692	0.300	0.169	0.094	0.074
416	2.306	0.171	2.297	2.432	1.591	0.761	0.331	0.186	0.104	0.081
420	2.506	0.185	2.466	2.613	1.712	0.821	0.358	0.201	0.112	0.087
424	2.689	0.200	2.650	2.804	1.840	0.886	0.387	0.217	0.122	0.095
428	2.879	0.217	2.844	3.009	1.976	0.956	0.419	0.236	0.132	0.102
432	3.068	0.233	3.038	3.217	2.111	1.022	0.449	0.253	0.141	0.110
436	3.275	0.250	3.253	3.446	2.258	1.094	0.482	0.272	0.152	0.119
440	3.514	0.266	3.443	3.648	2.393	1.160	0.511	0.289	0.161	0.126
444	3.744	0.282	3.663	3.880	2.546	1.232	0.543	0.307	0.171	0.134
448	3.966	0.300	3.887	4.113	2.702	1.309	0.577	0.325	0.182	0.142
452	4.179	0.318	4.109	4.345	2.861	1.388	0.611	0.345	0.193	0.151
456	4.378	0.335	4.314	4.562	3.017	1.466	0.645	0.364	0.203	0.159
460	4.585	0.355	4.516	4.784	3.179	1.551	0.684	0.386	0.215	0.168
464	4.816	0.374	4.697	4.979	3.319	1.629	0.720	0.406	0.227	0.177
468	4.985	0.391	4.853	5.143	3.435	1.695	0.752	0.425	0.237	0.185
472	5.135	0.408	5.014	5.303	3.536	1.753	0.782	0.442	0.246	0.193
476	5.338	0.428	5.247	5.542	3.684	1.828	0.817	0.463	0.258	0.203
480	5.620	0.451	5.555	5.869	3.885	1.922	0.861	0.489	0.271	0.215
484	5.872	0.471	5.847	6.178	4.075	2.005	0.898	0.510	0.283	0.224
488	6.210	0.489	6.124	6.474	4.263	2.089	0.933	0.530	0.294	0.233
492	6.526	0.508	6.404	6.772	4.457	2.177	0.969	0.550	0.305	0.242
496	6.809	0.525	6.664	7.038	4.634	2.259	1.002	0.568	0.316	0.250
500	7.050	0.542	6.894	7.276	4.793	2.336	1.034	0.586	0.325	0.257
504	7.270	0.560	7.135	7.530	4.964	2.419	1.069	0.605	0.336	0.266
508	7.548	0.583	7.421	7.829	5.165	2.521	1.114	0.629	0.349	0.277
512	7.824	0.608	7.704	8.125	5.366	2.625	1.161	0.655	0.364	0.289
516	8.100	0.632	7.967	8.403	5.556	2.722	1.205	0.681	0.377	0.300
520	8.388	0.658	8.235	8.685	5.747	2.825	1.254	0.709	0.393	0.313

Table 11. (cont.) Radiance outputs of CHORS 40-inch integrating sphere, measured with the NIST PR714 radiometer, and calibrated to the radiance scale of the GSFC sphere. (Radiances, $L_i(\lambda)$, are in units of $\mu\text{W cm}^{-2} \text{ nm}^{-1} \text{ sr}^{-1}$.)

λ [nm]	$L_1(\lambda)$	$L_2(\lambda)$	$L_3(\lambda)$	$L_4(\lambda)$	$L_5(\lambda)$	$L_6(\lambda)$	$L_7(\lambda)$	$L_8(\lambda)$	$L_9(\lambda)$	$L_{10}(\lambda)$
524	8.724	0.685	8.518	8.980	5.944	2.928	1.303	0.738	0.408	0.326
528	8.986	0.708	8.763	9.235	6.111	3.014	1.344	0.762	0.421	0.338
532	9.209	0.732	9.028	9.501	6.291	3.105	1.387	0.787	0.434	0.350
536	9.474	0.757	9.317	9.806	6.485	3.202	1.432	0.813	0.448	0.361
540	9.779	0.781	9.627	10.128	6.695	3.305	1.478	0.839	0.462	0.373
544	9.978	0.800	9.872	10.385	6.862	3.384	1.513	0.859	0.473	0.382
548	10.279	0.822	10.142	10.680	7.048	3.475	1.554	0.883	0.486	0.393
552	10.621	0.842	10.405	10.950	7.230	3.562	1.592	0.904	0.497	0.402
556	10.873	0.862	10.657	11.201	7.399	3.643	1.628	0.925	0.509	0.412
560	11.103	0.879	10.857	11.411	7.538	3.713	1.659	0.943	0.519	0.420
564	11.365	0.901	11.107	11.664	7.710	3.801	1.699	0.965	0.531	0.430
568	11.588	0.923	11.360	11.930	7.893	3.894	1.740	0.988	0.543	0.439
572	11.847	0.948	11.618	12.200	8.082	3.992	1.785	1.014	0.558	0.451
576	12.059	0.972	11.872	12.454	8.269	4.089	1.830	1.039	0.572	0.463
580	12.323	0.997	12.146	12.749	8.470	4.194	1.878	1.067	0.587	0.475
584	12.541	1.018	12.324	12.944	8.613	4.275	1.917	1.089	0.599	0.485
588	12.766	1.036	12.489	13.116	8.742	4.343	1.950	1.108	0.609	0.494
592	12.947	1.055	12.649	13.275	8.865	4.411	1.983	1.127	0.620	0.502
596	13.115	1.072	12.776	13.413	8.968	4.474	2.014	1.146	0.630	0.511
600	13.213	1.085	12.873	13.511	9.047	4.520	2.037	1.160	0.637	0.517
604	13.381	1.104	13.029	13.672	9.174	4.590	2.070	1.178	0.648	0.525
608	13.520	1.122	13.185	13.834	9.295	4.657	2.102	1.198	0.658	0.534
612	13.617	1.135	13.291	13.933	9.385	4.709	2.127	1.212	0.666	0.540
616	13.716	1.151	13.421	14.065	9.492	4.768	2.154	1.228	0.675	0.547
620	13.826	1.168	13.550	14.207	9.609	4.836	2.186	1.246	0.685	0.555
624	13.881	1.177	13.585	14.240	9.662	4.871	2.201	1.255	0.690	0.559
628	13.935	1.187	13.609	14.272	9.715	4.914	2.220	1.266	0.696	0.564
632	14.003	1.200	13.656	14.318	9.776	4.958	2.243	1.278	0.702	0.570
636	14.011	1.210	13.645	14.305	9.813	4.995	2.262	1.290	0.707	0.575
640	13.988	1.220	13.580	14.228	9.819	5.024	2.280	1.299	0.712	0.581
644	13.954	1.234	13.525	14.164	9.826	5.061	2.303	1.314	0.719	0.588
648	13.899	1.246	13.437	14.067	9.812	5.085	2.321	1.326	0.725	0.595
652	13.760	1.258	13.329	13.950	9.786	5.108	2.338	1.337	0.730	0.601
656	13.633	1.271	13.170	13.781	9.728	5.130	2.358	1.351	0.736	0.608
664	13.269	1.292	12.838	13.448	9.598	5.144	2.389	1.373	0.746	0.620
668	13.065	1.305	12.697	13.317	9.543	5.160	2.409	1.386	0.752	0.627
672	12.915	1.317	12.475	13.062	9.429	5.150	2.424	1.398	0.757	0.634
676	12.726	1.319	12.203	12.789	9.279	5.113	2.422	1.401	0.757	0.637
680	12.402	1.318	11.912	12.475	9.105	5.062	2.415	1.400	0.755	0.638
684	12.140	1.320	11.607	12.161	8.925	5.013	2.409	1.401	0.754	0.640
688	11.803	1.311	11.164	11.698	8.650	4.912	2.384	1.391	0.747	0.638
692	11.419	1.302	10.755	11.271	8.398	4.817	2.356	1.381	0.739	0.635
696	10.972	1.295	10.324	10.823	8.145	4.724	2.333	1.372	0.732	0.633
700	10.447	1.278	9.777	10.263	7.813	4.592	2.292	1.355	0.721	0.628
704	9.872	1.251	9.132	9.590	7.401	4.420	2.233	1.327	0.703	0.617
708	9.296	1.229	8.581	9.016	7.044	4.273	2.181	1.303	0.688	0.608
712	8.647	1.200	8.013	8.424	6.657	4.105	2.120	1.273	0.669	0.596

Table 11. (cont.) Radiance outputs of CHORS 40-inch integrating sphere, measured with the NIST PR714 radiometer, and calibrated to the radiance scale of the GSFC sphere. (Radiances, $L_i(\lambda)$, are in units of $\mu\text{W cm}^{-2} \text{ nm}^{-1} \text{ sr}^{-1}$.)

λ [nm]	$L_1(\lambda)$	$L_2(\lambda)$	$L_3(\lambda)$	$L_4(\lambda)$	$L_5(\lambda)$	$L_6(\lambda)$	$L_7(\lambda)$	$L_8(\lambda)$	$L_9(\lambda)$	$L_{10}(\lambda)$
716	8.001	1.158	7.360	7.747	6.183	3.886	2.033	1.228	0.643	0.578
720	7.400	1.118	6.808	7.166	5.761	3.685	1.952	1.187	0.618	0.562
724	6.855	1.073	6.301	6.638	5.356	3.476	1.865	1.139	0.591	0.541
728	6.286	1.022	5.839	6.155	4.967	3.259	1.768	1.085	0.562	0.517
732	5.792	0.958	5.364	5.656	4.545	3.006	1.651	1.018	0.526	0.486
736	5.384	0.901	5.017	5.287	4.222	2.795	1.548	0.957	0.495	0.457
740	5.052	0.848	4.743	4.995	3.959	2.608	1.453	0.899	0.467	0.428
744	4.764	0.801	4.557	4.797	3.763	2.462	1.373	0.850	0.443	0.402
748	4.615	0.755	4.400	4.630	3.592	2.327	1.293	0.799	0.421	0.375
752	4.492	0.713	4.272	4.491	3.456	2.214	1.224	0.754	0.402	0.350
756	4.363	0.674	4.153	4.363	3.337	2.113	1.159	0.712	0.383	0.326
760	4.200	0.644	4.088	4.293	3.257	2.042	1.111	0.679	0.370	0.307
764	4.170	0.628	4.099	4.300	3.240	2.011	1.087	0.661	0.364	0.295
768	4.188	0.617	4.118	4.314	3.235	1.994	1.069	0.648	0.359	0.287
772	4.199	0.606	4.129	4.319	3.224	1.975	1.054	0.637	0.355	0.281
776	4.207	0.597	4.140	4.332	3.213	1.956	1.040	0.627	0.351	0.275
780	4.215	0.589	4.160	4.347	3.206	1.942	1.027	0.618	0.347	0.270
784	4.235	0.584	4.207	4.387	3.217	1.933	1.019	0.612	0.344	0.266
788	4.285	0.581	4.253	4.439	3.236	1.934	1.015	0.609	0.343	0.265
792	4.331	0.578	4.307	4.491	3.259	1.933	1.011	0.605	0.341	0.262
796	4.370	0.574	4.362	4.550	3.282	1.932	1.005	0.600	0.340	0.259
800	4.445	0.573	4.437	4.620	3.322	1.941	1.005	0.599	0.340	0.258
804	4.522	0.572	4.503	4.688	3.363	1.950	1.005	0.598	0.340	0.257
808	4.571	0.569	4.558	4.742	3.389	1.954	1.001	0.594	0.339	0.254
812	4.630	0.568	4.623	4.804	3.425	1.965	1.001	0.592	0.339	0.252
816	4.710	0.569	4.683	4.862	3.467	1.979	1.004	0.593	0.340	0.252
820	4.779	0.570	4.749	4.929	3.515	1.997	1.008	0.594	0.342	0.252
824	4.851	0.574	4.824	5.009	3.572	2.024	1.018	0.598	0.345	0.252
828	4.928	0.579	4.891	5.078	3.628	2.053	1.028	0.604	0.349	0.254
832	4.972	0.585	4.941	5.129	3.671	2.077	1.038	0.609	0.351	0.256
836	5.017	0.590	4.985	5.175	3.713	2.101	1.049	0.614	0.354	0.259
840	5.049	0.595	5.018	5.208	3.743	2.121	1.058	0.619	0.357	0.261
844	5.064	0.600	5.029	5.223	3.761	2.138	1.067	0.625	0.360	0.264
848	5.049	0.605	5.028	5.222	3.772	2.152	1.074	0.629	0.362	0.266
852	5.067	0.610	5.039	5.232	3.792	2.166	1.083	0.636	0.364	0.270
856	5.074	0.616	5.041	5.234	3.797	2.178	1.092	0.641	0.367	0.273
860	5.062	0.620	5.028	5.217	3.800	2.188	1.099	0.646	0.369	0.276
864	5.037	0.623	5.006	5.197	3.794	2.191	1.102	0.649	0.370	0.278
868	5.015	0.625	4.971	5.161	3.778	2.188	1.104	0.651	0.370	0.279
872	4.954	0.623	4.919	5.110	3.742	2.174	1.099	0.649	0.368	0.279
876	4.884	0.620	4.854	5.048	3.702	2.158	1.094	0.647	0.366	0.279
880	4.845	0.619	4.811	4.995	3.666	2.143	1.090	0.645	0.364	0.279
884	4.805	0.615	4.751	4.930	3.627	2.123	1.082	0.641	0.362	0.277
888	4.719	0.606	4.652	4.836	3.560	2.090	1.066	0.632	0.356	0.274
892	4.599	0.590	4.504	4.685	3.445	2.028	1.037	0.615	0.347	0.267
896	4.422	0.569	4.322	4.491	3.305	1.948	0.999	0.593	0.334	0.257
900	4.203	0.546	4.139	4.299	3.169	1.866	0.959	0.570	0.321	0.247

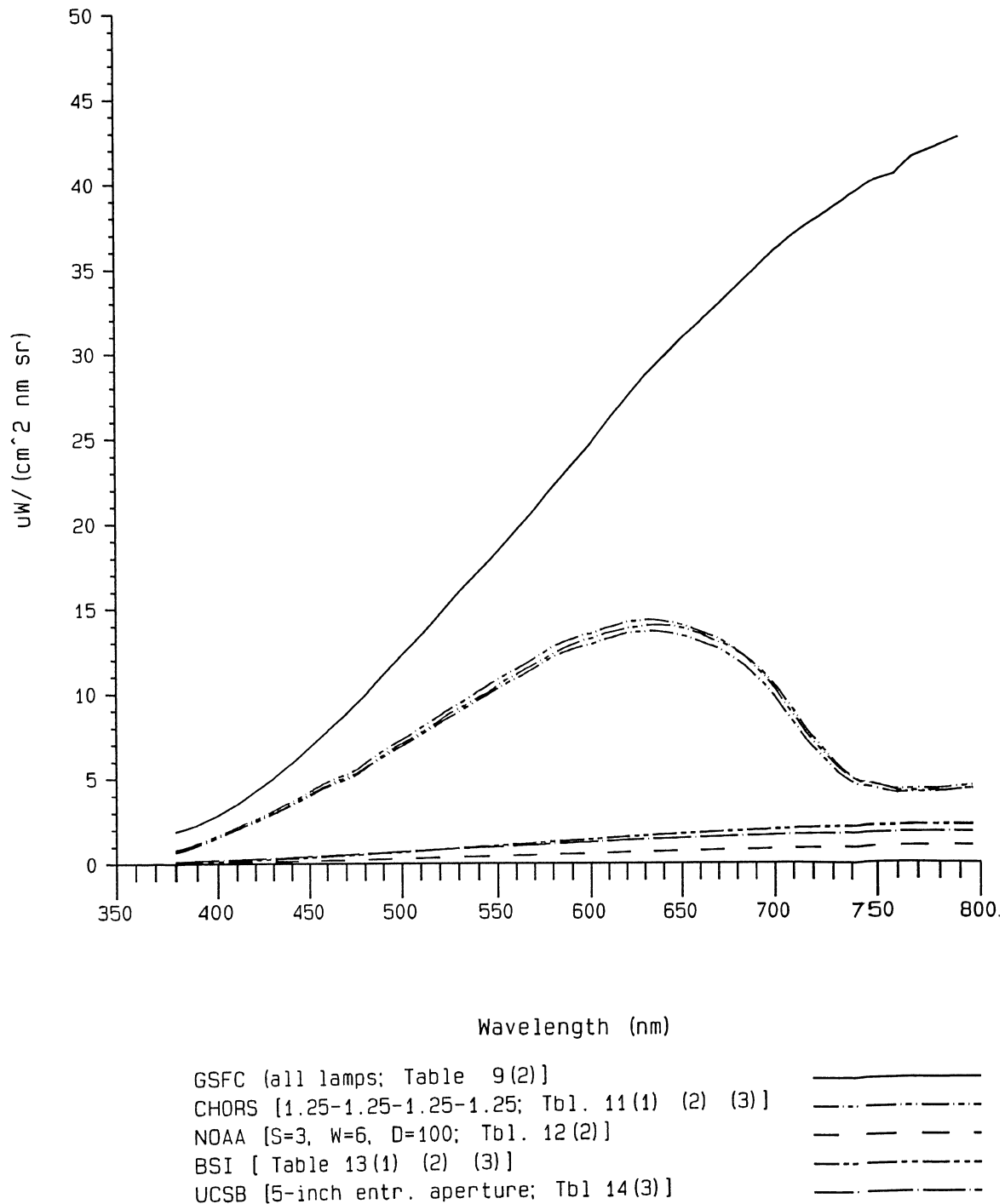

Fig. 16. Maximum levels of spectral radiance output compared for integrating sphere sources tested during SIRREX-1.

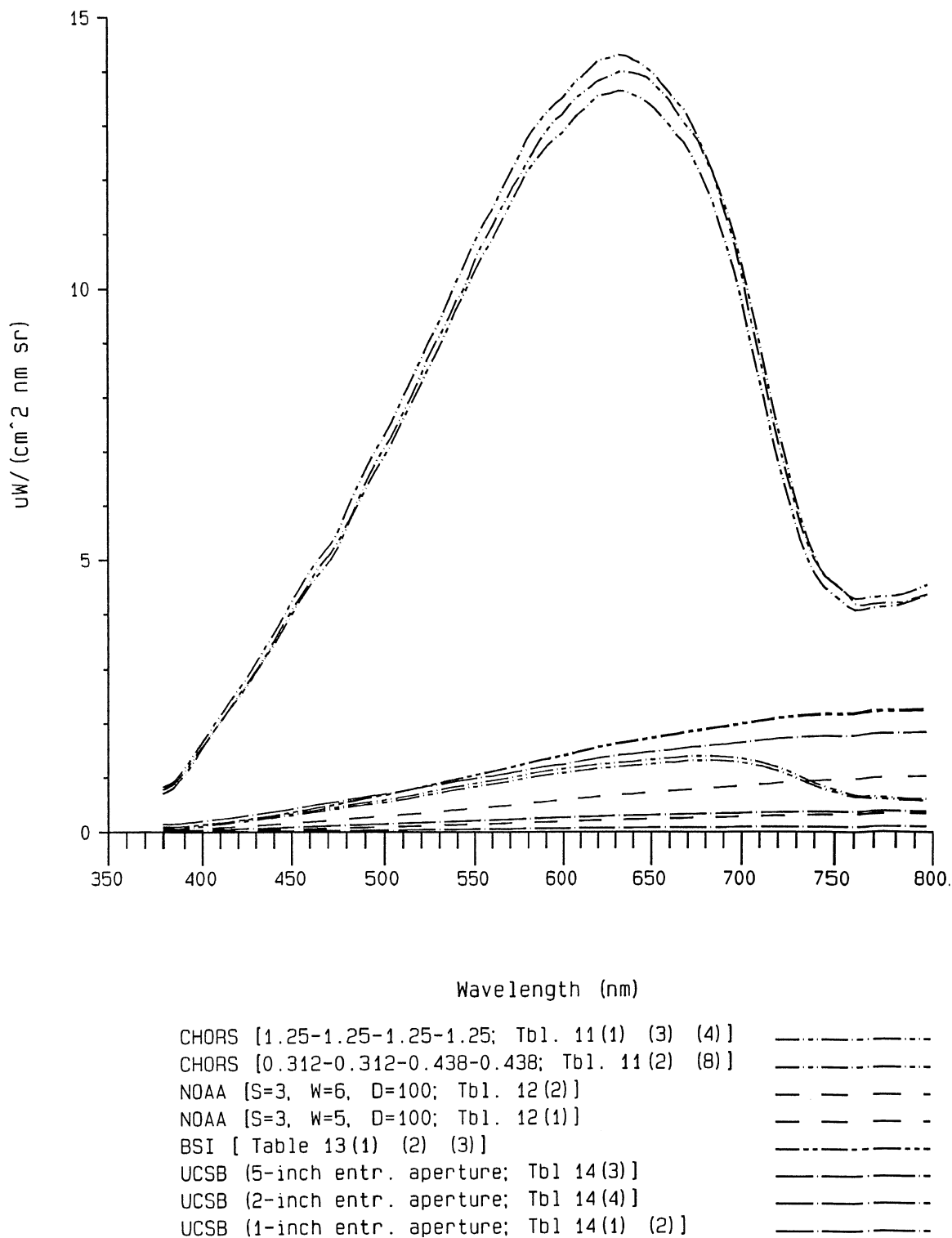

Fig. 17. Varying levels of spectral radiance output compared for integrating sphere sources tested during SIRREX-1.

Table 12. Radiance output of the NOAA Optronics 420M (S/N 92106057), measured with the NIST PR714 radiometer, and calibrated to the GSFC 42-inch sphere radiance scale. (Radiances, $L_i(\lambda)$, are in units of $\mu W cm^{-2} nm^{-1} sr^{-1}$.)

Run	File	Date	Optronics 420M Settings
1	SOP1NF02.SCN	28 July 1992	Slide=3, Wheel=5, and Distance=100
2	SOP1NF03.SCN	28 July 1992	Slide=3, Wheel=6, and Distance=100

λ [nm]	$L_1(\lambda)$	$L_2(\lambda)$	λ [nm]	$L_1(\lambda)$	$L_2(\lambda)$	λ [nm]	$L_1(\lambda)$	$L_2(\lambda)$
380	0.01661	0.05015	556	0.15185	0.45502	732	0.30966	0.92480
384	0.01776	0.05355	560	0.15516	0.46455	736	0.31272	0.93337
388	0.01911	0.05755	564	0.15903	0.47606	740	0.31456	0.93903
392	0.02082	0.06257	568	0.16283	0.48787	744	0.31686	0.94604
396	0.02274	0.06816	572	0.16752	0.50173	748	0.31874	0.95063
400	0.02431	0.07325	576	0.17174	0.51458	752	0.32013	0.95481
404	0.02625	0.07857	580	0.17626	0.52848	756	0.32222	0.96138
408	0.02823	0.08452	584	0.18052	0.54063	760	0.32589	0.97143
412	0.03020	0.09065	588	0.18420	0.55187	764	0.32948	0.98175
416	0.03274	0.09797	592	0.18794	0.56290	768	0.33201	0.98945
420	0.03476	0.10448	596	0.19190	0.57457	772	0.33472	0.99668
424	0.03719	0.11152	600	0.19515	0.58433	776	0.33684	1.00236
428	0.03985	0.11921	604	0.19911	0.59682	780	0.33842	1.00677
432	0.04222	0.12667	608	0.20384	0.61048	784	0.34083	1.01462
436	0.04501	0.13499	612	0.20794	0.62341	788	0.34401	1.02272
440	0.04759	0.14273	616	0.21213	0.63619	792	0.34570	1.02820
444	0.05044	0.15124	620	0.21719	0.65104	796	0.34709	1.03279
448	0.05355	0.16028	624	0.22047	0.66119	800	0.35011	1.04109
452	0.05675	0.16991	628	0.22425	0.67243	804	0.35233	1.04700
456	0.05966	0.17886	632	0.22785	0.68324	808	0.35236	1.04800
460	0.06310	0.18931	636	0.23076	0.69187	812	0.35343	1.05123
464	0.06633	0.19875	640	0.23345	0.70024	816	0.35489	1.05508
468	0.06910	0.20720	644	0.23749	0.71164	820	0.35548	1.05751
472	0.07193	0.21562	648	0.24071	0.72130	824	0.35657	1.06118
476	0.07554	0.22614	652	0.24346	0.72986	828	0.35873	1.06563
480	0.07969	0.23883	656	0.24721	0.74078	832	0.35956	1.06863
484	0.08344	0.24995	660	0.25075	0.75099	836	0.36034	1.07190
488	0.08711	0.26086	664	0.25361	0.75957	840	0.36188	1.07680
492	0.09076	0.27198	668	0.25720	0.77076	844	0.36362	1.08032
496	0.09429	0.28251	672	0.26155	0.78330	848	0.36469	1.08361
500	0.09756	0.29226	676	0.26404	0.79180	852	0.36647	1.08902
504	0.10090	0.30239	680	0.26651	0.79931	856	0.36786	1.09247
508	0.10487	0.31451	684	0.27009	0.80954	860	0.36835	1.09434
512	0.10912	0.32685	688	0.27285	0.81710	864	0.36864	1.09557
516	0.11273	0.33789	692	0.27493	0.82438	868	0.36982	1.09856
520	0.11663	0.34959	696	0.27886	0.83584	872	0.37042	1.10029
524	0.12080	0.36200	700	0.28271	0.84653	876	0.37090	1.10152
528	0.12428	0.37242	704	0.28525	0.85467	880	0.37148	1.10329
532	0.12830	0.38448	708	0.28909	0.86554	884	0.37165	1.10469
536	0.13266	0.39715	712	0.29265	0.87620	888	0.37181	1.10585
540	0.13695	0.41022	716	0.29579	0.88532	892	0.37236	1.10576
544	0.14049	0.42073	720	0.30046	0.89889	896	0.37273	1.10767
548	0.14446	0.43275	724	0.30346	0.90759	900	0.37223	1.10520
552	0.14802	0.44375	728	0.30621	0.91541			

Table 13. Radiance output of Biospherical Instruments, Inc., 20-inch integrating sphere (manufactured by Labsphere, Inc.) measured using the NIST PR714 radiometer, and calibrated to the radiance scale of the GSFC 42-inch sphere. (Radiances, $L_i(\lambda)$, are in units of $\mu\text{W cm}^{-2} \text{ nm}^{-1} \text{ sr}^{-1}$.)

			<i>Run</i>				<i>File</i>				<i>Date</i>
			1				SBS1NF02.SCN				28 July 1992
			2				SBS1NF03.SCN				28 July 1992
			3				SBS1NF04.SCN				30 July 1992
λ [nm]	$L_1(\lambda)$	$L_2(\lambda)$	$L_3(\lambda)$	λ [nm]	$L_1(\lambda)$	$L_2(\lambda)$	$L_3(\lambda)$	λ [nm]	$L_1(\lambda)$	$L_2(\lambda)$	$L_3(\lambda)$
380	0.09064	0.09148	0.09283	556	1.08623	1.08520	1.09855	732	2.13170	2.13170	2.15627
384	0.09731	0.09756	0.09794	560	1.10929	1.10929	1.12160	736	2.14496	2.14390	2.16938
388	0.10525	0.10462	0.10660	564	1.13755	1.13755	1.15095	740	2.15157	2.15052	2.17690
392	0.11556	0.11504	0.11630	568	1.16707	1.16707	1.18054	744	2.16055	2.15949	2.18585
396	0.12635	0.12719	0.12813	572	1.19925	1.20029	1.21380	748	2.16215	2.16110	2.18744
400	0.13743	0.13795	0.13984	576	1.23084	1.23084	1.24539	752	2.16198	2.16093	2.18833
404	0.15018	0.14997	0.15227	580	1.26557	1.26557	1.28013	756	2.16325	2.16325	2.19176
408	0.16355	0.16397	0.16596	584	1.29444	1.29444	1.30892	760	2.17613	2.17613	2.20468
412	0.17754	0.17743	0.17983	588	1.32084	1.31981	1.33523	764	2.19475	2.19475	2.22339
416	0.19484	0.19504	0.19764	592	1.34698	1.34698	1.36237	768	2.20705	2.20598	2.23472
420	0.21061	0.21071	0.21309	596	1.37424	1.37424	1.39068	772	2.21544	2.21437	2.24213
424	0.22823	0.22792	0.23102	600	1.39748	1.39748	1.41396	776	2.21879	2.21772	2.24557
428	0.24713	0.24734	0.25034	604	1.42743	1.42743	1.44404	780	2.21996	2.21888	2.24791
432	0.26531	0.26510	0.26923	608	1.45976	1.45976	1.47650	784	2.22657	2.22549	2.25460
436	0.28604	0.28604	0.28992	612	1.49013	1.48908	1.50697	788	2.23317	2.23317	2.26345
440	0.30481	0.30511	0.30886	616	1.52051	1.51945	1.53740	792	2.23635	2.23527	2.26562
444	0.32597	0.32608	0.33016	620	1.55423	1.55317	1.57224	796	2.23716	2.23607	2.26540
448	0.34849	0.34880	0.35293	624	1.57823	1.57718	1.59619	800	2.24450	2.24341	2.27388
452	0.37136	0.37146	0.37663	628	1.60418	1.60418	1.62208	804	2.24831	2.24722	2.27760
456	0.39352	0.39373	0.39899	632	1.62826	1.62826	1.64822	808	2.24124	2.24015	2.27154
460	0.41900	0.41900	0.42435	636	1.64846	1.64846	1.66837	812	2.23597	2.23489	2.26622
464	0.44255	0.44235	0.44799	640	1.66539	1.66643	1.68629	816	2.23251	2.23036	2.26273
468	0.46326	0.46357	0.46960	644	1.69084	1.69084	1.71075	820	2.22582	2.22582	2.25708
472	0.48459	0.48479	0.49105	648	1.71217	1.71217	1.73212	824	2.22545	2.22437	2.25564
476	0.51056	0.51046	0.51740	652	1.73241	1.73241	1.75238	828	2.22293	2.22185	2.25313
480	0.54179	0.54158	0.54871	656	1.75570	1.75570	1.77569	832	2.21793	2.21685	2.24821
484	0.57027	0.57027	0.57734	660	1.77694	1.77799	1.79694	836	2.21574	2.21465	2.24617
488	0.59706	0.59696	0.60489	664	1.79484	1.79484	1.81587	840	2.21454	2.21344	2.24620
492	0.62497	0.62538	0.63330	668	1.82005	1.82005	1.84105	844	2.21284	2.21064	2.24354
496	0.65131	0.65173	0.65998	672	1.84817	1.84607	1.86809	848	2.20885	2.20775	2.24078
500	0.67595	0.67626	0.68453	676	1.86551	1.86447	1.88642	852	2.21055	2.21055	2.24152
504	0.70147	0.70199	0.71037	680	1.88172	1.88172	1.90258	856	2.20916	2.20805	2.24026
508	0.73264	0.73264	0.74197	684	1.90413	1.90517	1.92609	860	2.20542	2.20319	2.23554
512	0.76376	0.76365	0.77307	688	1.92141	1.92141	1.94237	864	2.19960	2.19737	2.22967
516	0.79172	0.79193	0.80195	692	1.93718	1.93613	1.95825	868	2.19823	2.19600	2.22825
520	0.82138	0.82138	0.83147	696	1.96201	1.96095	1.98323	872	2.19281	2.19059	2.22388
524	0.85245	0.85276	0.86299	700	1.98379	1.98379	2.00623	876	2.18666	2.18445	2.21766
528	0.87918	0.87949	0.89038	704	1.99942	2.00050	2.02198	880	2.18273	2.18052	2.21366
532	0.90944	0.90985	0.92068	708	2.02265	2.02265	2.04533	884	2.17742	2.17411	2.20829
536	0.94129	0.94160	0.95247	712	2.04375	2.04375	2.06650	888	2.17209	2.16879	2.20180
540	0.97450	0.97450	0.98625	716	2.06047	2.06047	2.08324	892	2.16430	2.16210	2.19614
544	1.00057	1.00088	1.01316	720	2.08588	2.08588	2.11083	896	2.15618	2.15508	2.19014
548	1.03060	1.03081	1.04216	724	2.10190	2.10190	2.12673	900	2.14482	2.14482	2.17761
552	1.05801	1.05801	1.07033	728	2.11553	2.11553	2.14132				

Table 14. Radiance output of the UCSB 20-inch integrating sphere illuminated with lamp F303 at a distance of 50 cm, measured using the NIST PR714 radiometer, and calibrated to the radiance scale of the GSFC 42-inch sphere. (Radiances, $L_i(\lambda)$, are in units of $\mu\text{W cm}^{-2} \text{ nm}^{-1} \text{ sr}^{-1}$.)

Run	File	Date	Configuration
1	SUC1NF01.SCN	29 July 1992	1-inch Entrance Aperture
2	SUC1NF02.SCN	29 July 1992	1-inch Entrance Aperture
3	SUC1NF03.SCN	29 July 1992	5-inch Entrance Aperture
4	SUC1NF04.SCN	29 July 1992	2-inch Entrance Aperture

λ [nm]	$L_1(\lambda)$	$L_2(\lambda)$	$L_3(\lambda)$	$L_4(\lambda)$	λ [nm]	$L_1(\lambda)$	$L_2(\lambda)$	$L_3(\lambda)$	$L_4(\lambda)$
380	0.00803	0.00805	0.14385	0.03033	556	0.05819	0.05826	1.01744	0.21889
384	0.00854	0.00859	0.15149	0.03234	560	0.05922	0.05925	1.03335	0.22258
388	0.00923	0.00923	0.16296	0.03467	564	0.06041	0.06045	1.05504	0.22710
392	0.01005	0.01004	0.17713	0.03782	568	0.06154	0.06158	1.07689	0.23134
396	0.01089	0.01095	0.19267	0.04112	572	0.06296	0.06302	1.10052	0.23663
400	0.01158	0.01164	0.20556	0.04387	576	0.06422	0.06427	1.12480	0.24159
404	0.01243	0.01246	0.21955	0.04680	580	0.06550	0.06554	1.15118	0.24687
408	0.01327	0.01328	0.23343	0.05001	584	0.06681	0.06686	1.17244	0.25165
412	0.01408	0.01411	0.24828	0.05307	588	0.06792	0.06796	1.19132	0.25553
416	0.01514	0.01517	0.26605	0.05704	592	0.06894	0.06899	1.21054	0.25934
420	0.01600	0.01602	0.28146	0.06039	596	0.07013	0.07017	1.22931	0.26364
424	0.01702	0.01704	0.29874	0.06418	600	0.07094	0.07102	1.24506	0.26693
428	0.01815	0.01818	0.31710	0.06830	604	0.07209	0.07216	1.26859	0.27126
432	0.01913	0.01914	0.33499	0.07206	608	0.07356	0.07362	1.29233	0.27646
436	0.02024	0.02027	0.35466	0.07638	612	0.07463	0.07469	1.31333	0.28045
440	0.02137	0.02138	0.37257	0.08041	616	0.07569	0.07575	1.33573	0.28499
444	0.02253	0.02255	0.39291	0.08478	620	0.07717	0.07722	1.36141	0.29082
448	0.02375	0.02376	0.41364	0.08937	624	0.07803	0.07807	1.37858	0.29399
452	0.02506	0.02509	0.43589	0.09414	628	0.07900	0.07910	1.39562	0.29766
456	0.02619	0.02621	0.45679	0.09859	632	0.07994	0.08006	1.41396	0.30128
460	0.02750	0.02752	0.47987	0.10351	636	0.08059	0.08071	1.42629	0.30370
464	0.02877	0.02879	0.50145	0.10825	640	0.08122	0.08128	1.43748	0.30600
468	0.02986	0.02988	0.51979	0.11214	644	0.08223	0.08232	1.45408	0.30988
472	0.03089	0.03092	0.53721	0.11592	648	0.08306	0.08319	1.46863	0.31283
476	0.03226	0.03227	0.56002	0.12111	652	0.08371	0.08382	1.48222	0.31537
480	0.03379	0.03381	0.58821	0.12701	656	0.08449	0.08466	1.49798	0.31864
484	0.03515	0.03518	0.61278	0.13230	660	0.08545	0.08556	1.51272	0.32191
488	0.03657	0.03659	0.63612	0.13739	664	0.08600	0.08610	1.52567	0.32438
492	0.03793	0.03796	0.65951	0.14237	668	0.08691	0.08699	1.54489	0.32778
500	0.04031	0.04034	0.70066	0.15120	672	0.08811	0.08819	1.56303	0.33189
504	0.04147	0.04150	0.72135	0.15560	676	0.08864	0.08873	1.57481	0.33410
508	0.04284	0.04286	0.74632	0.16093	680	0.08903	0.08910	1.58548	0.33598
512	0.04434	0.04437	0.77162	0.16658	684	0.08998	0.09004	1.59984	0.33931
516	0.04553	0.04556	0.79400	0.17127	688	0.09057	0.09068	1.61008	0.34130
520	0.04685	0.04687	0.81706	0.17614	692	0.09089	0.09099	1.61906	0.34267
524	0.04830	0.04833	0.84181	0.18136	696	0.09191	0.09197	1.63625	0.34635
528	0.04941	0.04945	0.86206	0.18579	700	0.09279	0.09286	1.65030	0.34973
532	0.05075	0.05077	0.88476	0.19068	704	0.09317	0.09326	1.65992	0.35132
536	0.05224	0.05225	0.90972	0.19612	708	0.09405	0.09413	1.67600	0.35432
540	0.05358	0.05363	0.93525	0.20149	712	0.09479	0.09484	1.69067	0.35730
544	0.05459	0.05461	0.95436	0.20563	716	0.09519	0.09525	1.70062	0.35931
548	0.05592	0.05597	0.97674	0.21039	720	0.09634	0.09641	1.71925	0.36348
552	0.05705	0.05709	0.99781	0.21458	724	0.09699	0.09703	1.72946	0.36532

Table 14. (cont.) Radiance output of the UCSB 20-inch integrating sphere illuminated with lamp F303 at a distance of 50 cm, measured using the NIST PR714 radiometer, and calibrated to the radiance scale of the GSFC 42-inch sphere. (Radiances, $L_i(\lambda)$, are in units of $\mu\text{W cm}^{-2} \text{ nm}^{-1} \text{ sr}^{-1}$.)

λ [nm]	$L_1(\lambda)$	$L_2(\lambda)$	$L_3(\lambda)$	$L_4(\lambda)$	λ [nm]	$L_1(\lambda)$	$L_2(\lambda)$	$L_3(\lambda)$	$L_4(\lambda)$
728	0.09735	0.09741	1.73841	0.36691	816	0.10293	0.10296	1.85593	0.38802
732	0.09786	0.09792	1.74810	0.36907	820	0.10266	0.10269	1.85503	0.38728
736	0.09841	0.09843	1.75632	0.37091	824	0.10242	0.10251	1.85777	0.38719
740	0.09848	0.09855	1.76115	0.37122	828	0.10278	0.10283	1.86053	0.38796
744	0.09872	0.09881	1.76724	0.37211	832	0.10273	0.10281	1.85891	0.38779
748	0.09873	0.09882	1.76702	0.37216	836	0.10250	0.10253	1.86040	0.38718
752	0.09845	0.09856	1.76669	0.37178	840	0.10278	0.10280	1.86292	0.38765
756	0.09849	0.09856	1.76945	0.37194	844	0.10296	0.10301	1.86523	0.38818
760	0.09917	0.09924	1.77960	0.37390	848	0.10289	0.10295	1.86530	0.38781
764	0.09984	0.09991	1.79378	0.37679	852	0.10310	0.10317	1.86885	0.38859
768	0.10025	0.10032	1.80267	0.37852	856	0.10319	0.10323	1.87040	0.38885
772	0.10083	0.10089	1.81079	0.38031	860	0.10288	0.10290	1.86853	0.38798
776	0.10107	0.10111	1.81488	0.38108	864	0.10251	0.10252	1.86548	0.38713
780	0.10114	0.10120	1.81789	0.38142	868	0.10255	0.10262	1.86688	0.38727
784	0.10152	0.10157	1.82546	0.38278	872	0.10253	0.10260	1.86544	0.38663
788	0.10221	0.10225	1.83412	0.38488	876	0.10232	0.10242	1.86115	0.38596
792	0.10222	0.10229	1.83851	0.38559	880	0.10212	0.10219	1.86018	0.38540
796	0.10218	0.10226	1.84186	0.38575	884	0.10177	0.10184	1.85770	0.38433
800	0.10288	0.10297	1.85174	0.38776	888	0.10147	0.10152	1.85519	0.38336
804	0.10328	0.10334	1.85767	0.38890	892	0.10131	0.10141	1.85135	0.38257
808	0.10286	0.10295	1.85489	0.38786	896	0.10107	0.10117	1.84831	0.38171
812	0.10276	0.10277	1.85467	0.38757	900	0.10046	0.10056	1.84092	0.37977

FEL lamp 91453 at a distance of 240 cm. Tabulations of spectral irradiance emitted by lamp 91453 are given in Table 4, both as determined independently at BSI by in-house transfer from a local working standard scale of spectral irradiance, and as determined during the transfer of 31 July 1992 from F269 (Section 3.1).

In principal, the measured radiances and calibrated irradiance of lamp 91543 could be combined to calculate the BRDF of each plaque for normal incident illumination and reflectance at 45° . In the present case, however, the absolute radiometer calibration scale of the PR714, as transferred from the GSFC 42-inch sphere, varied over a range of 3% during SIRREX-1 (Fig. 15), and the accuracy of the transfer of the F269 spectral irradiance scale to 91453 on 31 July 1992 (Section 3.1) is uncertain by greater than 5% at 400 nm, and up to 2% at longer wavelengths (Fig. 8). The spectral BRDF must be determined with an accuracy of less than 1%, for a plaque to be used to transfer spectral irradiance to radiance for instrument calibration, and this particular data will not support such a determination. Therefore, BRDF calculations from the data acquired during the July 1992 comparisons are not presented.

In terms of relative BRDFs, the spectral irradiances reflected at 45° from plaques belonging to NOAA, BSI, and UCSB agreed within less than 1% at all wavelengths. The spectral irradiances reflected from the CHORS plaque were approximately 3.5% lower than those reflected from the BSI plaque at 400 nm, with the discrepancy decreasing

monotonically to 1.5% at 700 nm; this difference suggests that the CHORS plaque may have become contaminated with dirt, and that it should be cleaned and retested.

3.4 Shunt and Voltmeter Tests

Current shunt resistors and $5\frac{1}{2}$ -digit voltmeters are used to measure lamp currents at the participating laboratories.

Shunt resistors belonging to BSI, GSFC, UM, NOAA, and CHORS were all connected in parallel to measure lamp current supplied to an FEL lamp by an Optronics 83DS current-regulated power supply, set to deliver 8.000 A at a nominal 110 VDC. Assuming that the GSFC shunt was calibrated exactly at 0.01Ω , all of the other shunt resistances, as calculated from the voltage drop during the test, matched their independent calibration values within less than $1.0 \mu\Omega$.

Precision voltmeters ($5\frac{1}{2}$ -digit resolution or better) belonging to BSI, Satlantic, NIST, GSFC, UM, and CHORS were compared by sequentially measuring the voltage drop across one of the shunts during the above test. The meters belonging to BSI, Satlantic, NIST, and GSFC agreed to within $3 \mu\text{V}$; the CHORS meter read $69 \mu\text{V}$ low, and the UM meter read $30 \mu\text{V}$ high compared to the average of these four. While the CHORS and UM meter discrepancies are less than 0.1% of reading, and are more than sufficiently accurate for lamp current determination, they

exceed the $5\frac{1}{2}$ -digit precision specification of the meters, and should therefore, be recalibrated.

3.5 Optronics 746 Stability Tests

The GSFC Optronics 746 Spectroradiometer system, configured with an ISIC as described in Section 2.1, was tested for short-term stability in February 1993. These tests were prompted by the apparent lack of stability in the lamp irradiance scale transfers, using this radiometer, on 31 July 1992 (Section 3.1). It is noteworthy, however, that the 746/ISIC was refurbished by the manufacturer (Optronics, Inc.) immediately following SIRREX-1 and reconfigured with a grating extending from 350–1,100 nm. (During SIRREX-1, the 746/ISIC was equipped with a grating designed to measure near-infrared spectral irradiance, with its lower wavelength limit at 400 nm.) Moreover, the manufacturer recommended an operating procedure for manually setting the phase angle of the 746's chopper system, whereas the auto-phasing setting was employed by GSFC personnel during the July 1992 lamp transfer measurements. The recommended phase angle operating procedure was used during the February 1993 stability tests.

The laboratory procedure consisted of a series of measurements of spectral irradiance emitted by a seasoned FEL lamp at one-half hour intervals, over a total duration of 4 hours. The 746/ISIC and lamp setup configuration was identical to that described for irradiance scale transfer in Section 2.1 above. The 746/ISIC system was powered on and allowed to warm up for approximately one hour before commencement of the tests. The initial phase angle was set manually and readjusted for peak output prior to each lamp run (following the manufacturer's recommended procedure). FEL lamp 89157 was warmed up for approximately 10 minutes, and then its spectral irradiance output (at 50 cm) was scanned from 350–1,100 nm, with the 746/ISIC voltage responses recorded at 10 nm intervals. This procedure was repeated at one-half hour intervals, with the first run at 1230 PST and the final run at 1630 PST.

Lamp voltage and current were monitored throughout each run, and the lamp was powered down at the end of each test and warmed up for 10 minutes before the start of the next run. The 746/ISIC was kept powered up during the wait between tests. The results of the 9 spectral irradiance measurements, expressed as percent variation from the mean of the 9 runs at each wavelength, are illustrated in Fig. 18. The 746/ISIC system drifted over a total range of approximately 2%, with the largest responsivity changes occurring during the first 1.5 hours of the test (2.5 hours of operation, including the 1 hour warmup). Responses were stable within a 1% range between 1400 and 1630 PST, with the largest drift evidenced near 400 nm (Fig. 18). These results clearly suggest the GSFC Optronics 746/ISIC should be warmed up for at least 3 hours before commencing lamp irradiance scale transfer measurements. For full-day test

sessions, like those described in Section 3.1 above, the system should probably be allowed to remain powered up overnight so that measurements can begin at the start of each workday.

3.6 GSFC and SBRC Source Comparisons

The GSFC 42-inch sphere, Optronics 746/ISIC, and FEL lamps were transported to SBRC in October 1992 for intercomparison with the radiometric sources used by SBRC to calibrate the SeaWiFS instrument. These intercomparisons, which were performed on 26–28 October 1992, are reported here in Appendix B. The spectral radiance scales of the SBRC and GSFC integrating sphere sources were found to agree to within less than 3%. The GSFC sphere radiance scale was checked by transfer from FEL lamp F269 using the 746/ISIC (Section 2.2). The radiance scale of the SBRC sphere had been determined at some previous time (the date is not specified in Appendix B) and was not checked independently against the SBRC working standard of spectral irradiance (DXW lamp SS27) during the experiment. SBRC did transfer the irradiance scale of lamp SS27 to the GSFC sphere, using a Halon reflectance plaque and a Cary 14 spectrophotometer, which had been modified to function as a transfer radiometer (Appendix B). The results of this transfer yielded a scale of spectral irradiance which disagreed with the GSFC scale by greater than 25% at 400 nm and by approximately 10% at all wavelengths greater than 500 nm.

Intercomparisons were also made between the spectral irradiance scales of FEL lamp F269 and DXW lamp SS27, first using the GSFC 746/ISIC setup to transfer the F269 scale to SS27, and then using the SBRC Cary 14 for the reverse transfer. The GSFC 746/ISIC transfer of the (NIST October 1992) spectral irradiance scale of F269 to SS27 was higher than the SBRC SS27 scale by about 2–6%. On the other hand, the SBRC Cary 14 transfer of the SS27 scale to F269 was higher than the NIST October 1992 calibrated scale of F269, by up to 10%. The discrepancies in these two scale comparisons are not internally consistent, i.e., they are in opposite directions and cannot be reconciled by assuming that one or the other scales was in error. At this writing, GSFC's lamp F269 has been sent to SBRC for a repeat comparison between its irradiance scale and that of SS27 using the SBRC equipment. The forthcoming results of those tests will indicate the direction further follow-up actions, if any, should take to assure internal consistency between the calibrations of *in situ* radiometers and the SeaWiFS instrument itself.

The SDSU CHORS prototype QED-200 filter wheel transfer radiometer was also used to compare the GSFC and SBRC spheres on 28 October 1992. The measurements with this system were not internally consistent within 4% in most cases, and were significantly worse in some channels. After careful analyses of these data and subsequent

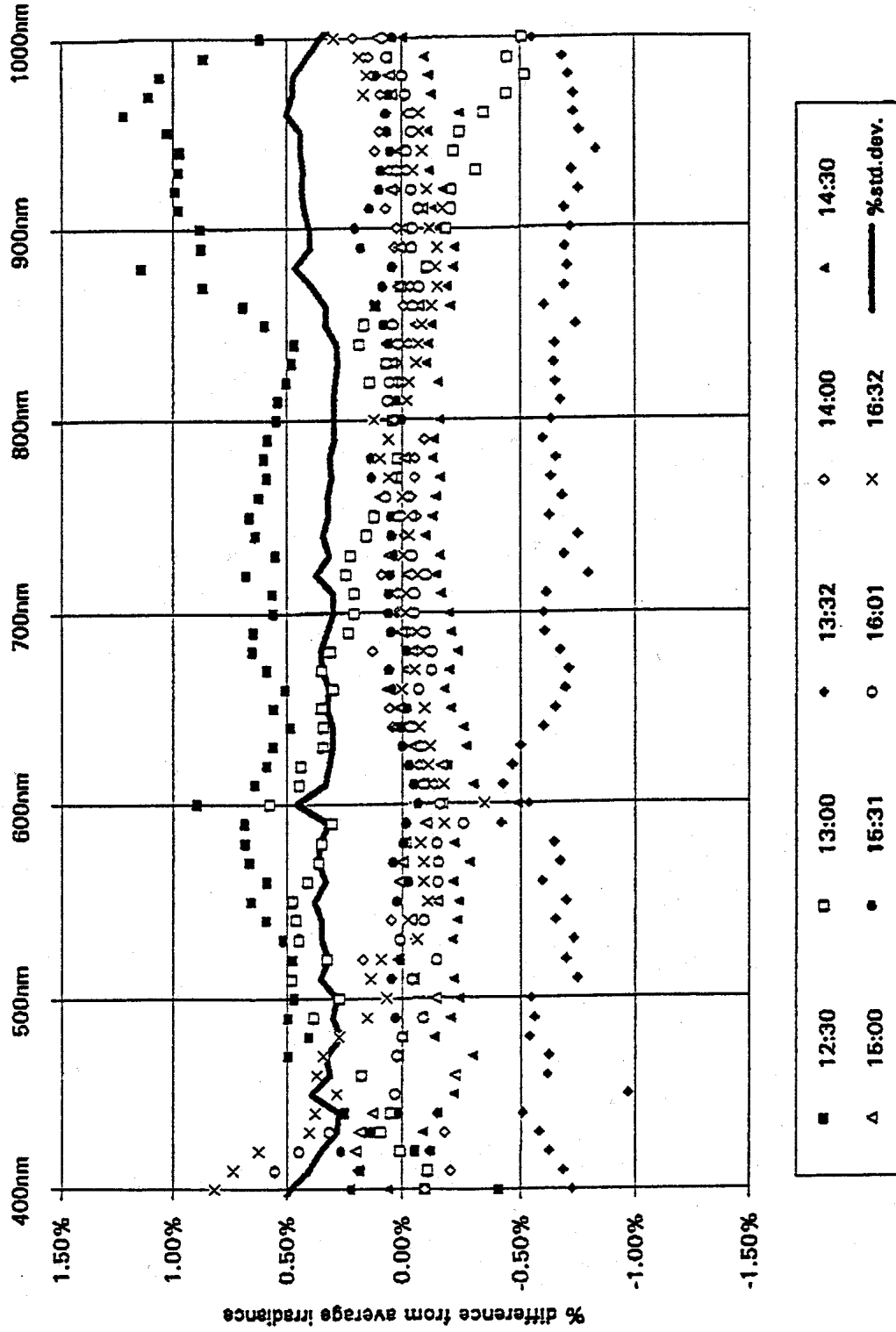

Fig. 18. Short-term relative variability in measurements with the GSFC Optronics 746/ISIC spectroradiometer of spectral irradiance at 50 cm for FEL lamp 89157. These measurements were performed at GSFC in February 1993 to test the short-term stability of the 746 system.

measurements at CHORS, it was determined that the design and fabrication of the Gershun tube and filter assembly, and internal baffling, were not adequate for this version of the instrument to be used for reliable transfers, and therefore, these data are not presented here. A revised design of this instrument will be fabricated to correct these deficiencies in time for testing during the next SIRREX in June 1993.

4. DISCUSSION AND CONCLUSIONS

The first SIRREX experiment in July 1992 was an extremely valuable exercise for the participating community, albeit more as a learning experience than as a fully successful intercalibration. Although some results of the intercalibration meet accuracies which will support the SeaWiFS validation requirements, the majority of intercomparisons fall short of that standard.

The 30 July 1992 transfers of the NIST (October 1992 through post-calculation) F269 irradiance scale to lamps F268, F307, and F308 are thought to be accurate within 1%. The resulting scales for those lamps (Table 2) are internally consistent and meet SeaWiFS goals.

The 31 July 1992 transfers of the F269 scale to the other lamps (Tables 4–7) were not sufficiently precise to meet SeaWiFS standards. In the majority of cases, therefore, improved transfers must be effected during future intercalibrations. During the next SIRREX, the 746/ISIC will be allowed to warm up for several hours before commencement of lamp transfer measurements. Also, a subset of the lamp scales will be independently checked with a different transfer radiometer setup to assure that the desired precision is attained.

As an additional step to improve our intercalibration of irradiance scales, a series of blind tests has been initiated. GSFC has transferred the F269 irradiance scale (NIST October 1992) to another FEL lamp, and then it in turn, was used to transfer the scale from that lamp to a small sample of other FEL lamps provided by other participating laboratories (so far BSI and CHORS). The GSFC reference FEL lamp and its irradiance scale are then mailed sequentially to the other laboratories, where it will be independently transferred to the same small sample of FEL lamps in a blind test. After several laboratories have performed these blind transfers, the resulting independently transferred irradiance scales will be intercompared to determine the precision of scale transfers at, and between, the various laboratories. Improved procedures can then be implemented where warranted.

Based on multiple measurements with the PR714, the spectral radiance scale of the GSFC sphere appears to be stable to within less than 3%. Possible sources of this variability are short-term instabilities in the PR714 radiometer, variability in the lamp illumination of the sphere, and spatial inhomogeneity in the radiance distribution in the sphere's exit port. Based on repeated 746/ISIC measurements of the sphere's irradiance scale by GSFC, the scale

appears to be repeatable within less than 2% over periods of many months. No information is currently available on the short-term stability of the PR714 Spectrascan radiometer's spectral responsivity; nor has the radiance distribution of the sphere's exit port been mapped. Both of these possible sources of apparent scale variability should be investigated, and a better error budget developed, either before, or during, the next SIRREX.

For the present, it would seem appropriate for BSI, UCSB, and NOAA to apply the spectral radiance scales given in Tables 12–14. It would also be appropriate, however, to independently test the long term stability of these radiance scales, either using built-in photodiode detectors (BSI), or external radiometers, and make appropriate adjustments. The radiance scales of these sources will be retested during the next SIRREX exercise.

Radiance scale measurements on the CHORS sphere point out the need to re-lamp it to achieve a better gray-body radiance spectrum, i.e., by eliminating the dichroic reflectors in the original lamp configuration. This has been accomplished; the sphere is now lamped with four 150 W tungsten-halogen lamps mounted in aluminum parabolic reflectors to illuminate the entrance ports of the vestibule spheres, which in turn illuminate the main 40-inch sphere with diffuse radiance. The radiance scales listed in Table 11 for this sphere no longer apply and this sphere will be recharacterized during the next SIRREX in June 1993.

The results, and shortcomings, associated with the first SIRREX in July 1992, suggest many procedural modifications which should be implemented before, and during, the next SIRREX in June 1993:

1. One week is an insufficient amount of time to carry out such a broad experimental program of radiometric intercomparisons involving so many different groups. Two weeks have been scheduled for the June 1993 SIRREX.
2. Software and data formats should be organized to facilitate near-real time analyses of all measurements made during future SIRREXs. The SeaWiFS Project will provide assistance in database management (see Appendix C). In addition, software and format conversions should be organized to put all data into a pre-established framework of tables and graphs within a few hours of data acquisition.
3. Detailed experimental procedure check lists and log forms should be developed in advance of, and used during, each future SIRREX. During the July 1992 exercise, the participants depended solely on records documented in notebooks by the participating scientists and engineers. Furthermore, many procedural details, e.g., source and detector placements and distances, were established on a purely ad hoc basis and were recorded in a relatively uncontrolled way. In

retrospect, many of these details can be anticipated. To ensure an orderly implementation, they should be itemized on detailed experiment check list forms, which can then be filled out during each experiment by a designated lead scientist or engineer.

4. The procedure for propagating the NIST scale of spectral radiance through GSFC to the SeaWiFS community should be strengthened. Prior to the next SIRREX, the calibration of transfer radiometers and their relationships to the NIST and GSFC sphere scales of spectral radiance should be reconsidered to determine any needed changes. During the next SIRREX, the new SeaWiFS transfer radiometer, which NIST is building for the Project, will be employed. More systematic radiance scale verification tests should be coordinated and planned using the NIST calibrated broad-band photodetectors (Appendix A). Each participant should also provide, in advance, data sheets detailing precise dimensions and areas of exit and entrance ports of any integrating sphere sources to be characterized during the round-robin.
5. Each integrating sphere source of spectral radiance should be mapped to determine the variability of radiance distribution over its exit port. There is unlikely to be sufficient time available to attempt this mapping during the round-robin, and it would be better if each participant did this independently and provided the results at the outset of the experiment.
6. Spectral BRDFs of reflectance plaques used to transfer spectral irradiance scales to radiance scales should be measured with an accuracy to within 1%. NIST will provide reflectance standards for this purpose during the June 1993 SIRREX, but detailed laboratory procedures for the BRDF determinations have yet to be specified and scheduled.

At this time, the relationship between the SBRC radiometric scales used to calibrate the SeaWiFS instrument, and the GSFC/NIST scales have not been determined with sufficient precision. The principal uncertainty appears to be associated with the lack of a proven internal consistency between the underlying spectral irradiance scales of lamps F269 (GSFC) and SS27 (SBRC); this uncertainty may be resolved by tests presently in progress. In addition, however, the pathway from the irradiance scale of SS27 to the SBRC sphere has not been adequately documented within the SeaWiFS Project, and it should be. The radiance scales of the SBRC and GSFC spheres do appear to agree within 3%, which is approximately the same repeatability obtained with PR714 spectral measurements of the GSFC sphere.

This consistency between the two spheres will provide the primary linkage between SeaWiFS radiance responsivity calibration and the SIRREX intercalibration process, but it is important that the heritage of the SBRC sphere radiance scale is better understood. Even with improved repeatability of the GSFC sphere scale, e.g., through mapping of radiance variability, any improvement of the 3% level of precision in comparison to the SBRC sphere would require a similar mapping of radiance variability in its exit port. These questions should continue to be developed and considered as SIRREX activities proceed through the summer of 1993.

ACKNOWLEDGMENTS

In addition to some of the participants, several people contributed to the preparation of this document. In particular, the author thanks Carol Johnson, James McLean, and Robert Woodward for the material presented in Appendices A, B, and C, respectively.

APPENDICES

- A. NIST Photodetector Results
- B. Radiometric Source Comparison at SBRC
- C. Intercalibration Data Archive
- D. Attendees to SIRREX-1

Appendix A

NIST Photodetector Results

Spectral radiance measurements were made at CHORS of the GSFC sphere, the CHORS sphere, the BSI sphere, and the NOAA (Optronics) sphere using a commercial, imaging monochromator that has a single grating and a linear diode array (the PR714).

Using this device, NIST recorded the spectral radiance of a calibrated sphere source (the FASCAL sphere source with a 1 in. aperture) before and after SIRREX-1. The best data are those from the measurements after the CHORS visit; the current set at the calibration value was available for these runs. It appears that the PR714 measurements at CHORS should be low by several percent, except below 400 nm, where the PR714 appears to measure high (Fig. A1, derived from files `ISS5.SCN` and `SSCALSUM.WQ1`). This is noted in passing, as the calibration of the NASA sphere will be used as the reference.

GSFC brought their 42-inch sphere source with accompanying calibration data. During the round-robin, C. Cromer referenced the scans of the spheres taken with the PR714 to the GSFC sphere calibration data (Fig. A2), and took the average of two PR714 scans on the sphere (files `SGD2NF01.SCN` and `SGD2NF02.SCN` on 28 July 1992) for the measured spectral radiance for the GSFC sphere at CHORS using the PR714.

Fig. A2 shows the following interpolated onto the wavelength grid of the PR714 and referenced to the GSFC sphere: the reference spectral radiance from GSFC for their sphere; corrected data for CHORS (file `SCH3NF01.SCN` on 28 July 1992); corrected PR714 data for BSI (file `SBS1NF02.SCN`); and corrected PR714 data for the NOAA sphere (file `SOP1NF02.SCN`).

Using calibrated filter-radiometers, NIST measured the integrated spectral radiance for the GSFC, CHORS, and BSI

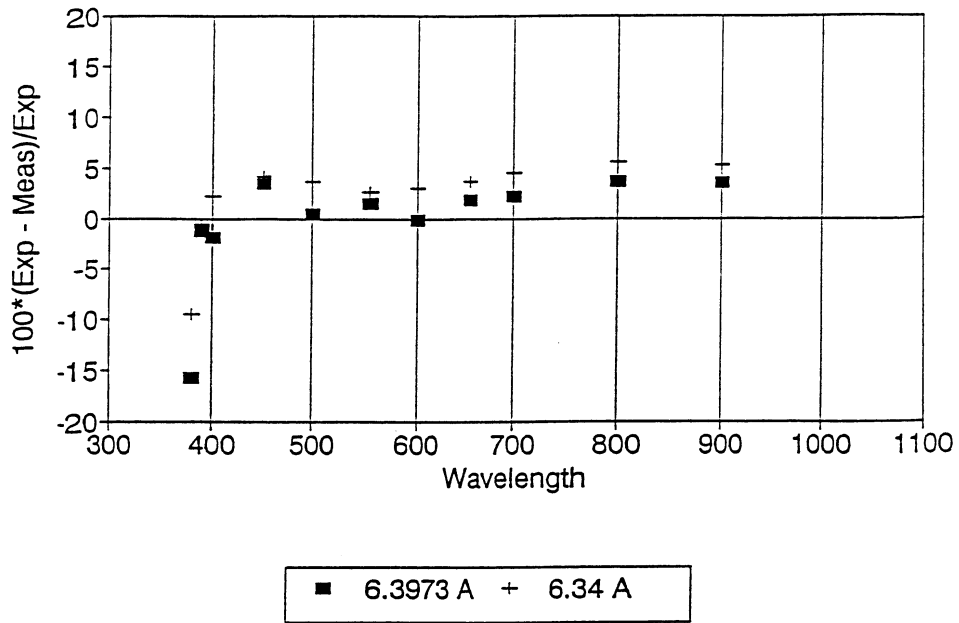

"Exp" = Expected value based on NIST sphere calibration before the July 1992 Round Robin Calibration
 "Meas" = Value measured from the FASCAL sphere after the July 1992 SeaWiFS Round Robin Calibration

Fig. A1. Spectrum of differences in calibration of the PR714 Spectrascan imaging monochromator after SIRREX-1, relative to the previous calibration.

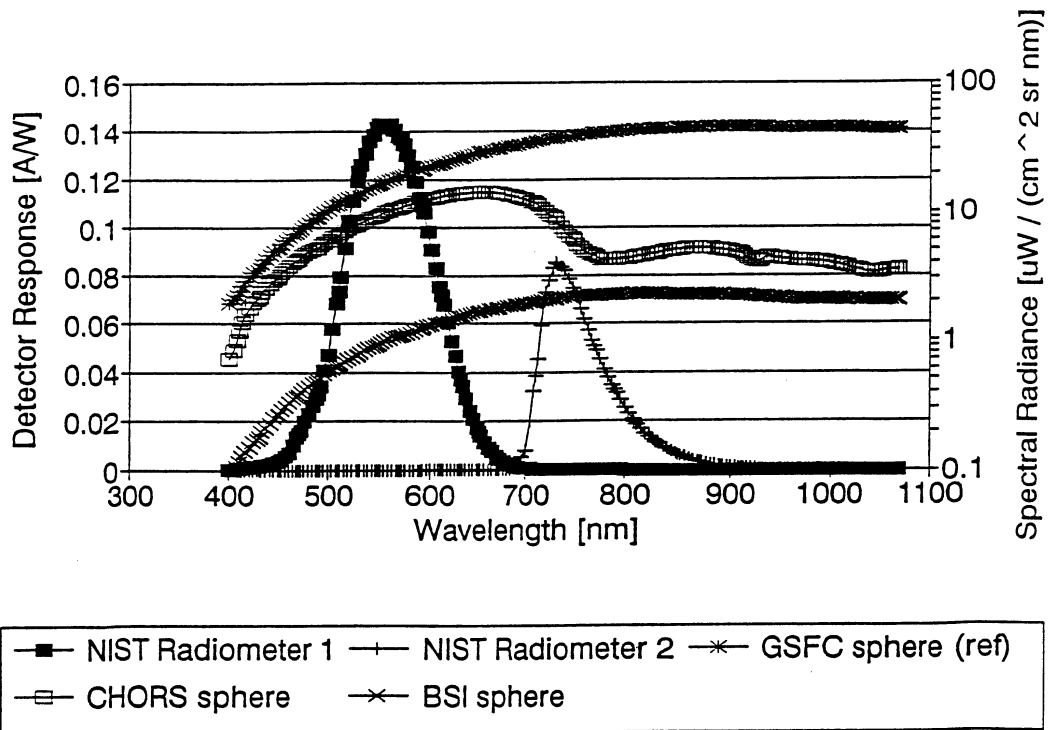

Fig. A2. Comparison of the spectral radiances of the GSFC, CHORS, and BSI spheres measured during SIRREX-1 (see also Section 3.2), and the spectral response functions of NIST filter radiometers.

spheres. Last July, predicted signal values were calculated by integrating the PR714 data and then weighting them by the spectral response functions of the two radiometers (Fig. A2). More recently, NIST calculated what the signals should have been based on the GSFC sphere calibration data. The GSFC photodetector measurements were made on 28 July immediately after the files SGD2NF01 and SGD2NF02 were recorded. The CHORS measurements were made on the morning of 29 July. The BSI measurements were made on 28 July 1992 immediately after SBS1NF03 was recorded. The NOAA sphere was too weak for photodetector measurements. The results (in current) are given in Table A1.

Table A1. Photodetector measurements.

Group	Measured	Calculated	Agreement
<i>Filter Radiometer at ~550 nm</i>			
BSI	1.757×10^{-8}	11.806×10^{-8}	2.8 %
CHORS	7.340×10^{-8}	9.690×10^{-8}	32.0
GSFC	2.649×10^{-7}	2.641×10^{-6}	-0.3†
<i>Filter Radiometer at ~720 nm</i>			
BSI	2.877×10^{-9}	2.927×10^{-9}	1.7 %
CHORS	3.171×10^{-9}	4.111×10^{-9}	29.6
GSFC	4.578×10^{-7}	4.538×10^{-7}	-0.9

†Assumes the gain was (as is believed) written down incorrectly.

The conclusions from the NIST photodetector results are as follows:

1. The NIST photodetectors, and the ancillary data on the PR714 and the NIST sphere, support the conclusion that the calibration assigned to the GSFC sphere is closer to the truth than the radiometric scale on the PR714.
2. The CHORS sphere was not set to the same level on the two different days, so a comparison of the photodetector and PR714 results is not consistent. The other possibility is that the separation between the CHORS sphere and the photodetectors was recorded incorrectly. Also, the sphere aperture could have been measured incorrectly.
3. When used correctly, the photodetectors provide independent confirmation of the spectral radiance (or irradiance) scales.

Appendix B

Radiometric Source Comparison at SBRC

The GSFC scales of spectral irradiance and radiance were compared with those of SBRC on 26–28 October 1992. These comparisons at SBRC were part of the overall SIRREX effort to provide traceability between data sets obtained by different researchers performing *in situ* optical measurements. These data are to be used for SeaWiFS baseline algorithm development and system validation.

The primary goal of the tests at SBRC was to compare the radiance output of the SeaWiFS flight instrument calibrator at SBRC with that of the 42-inch integrating sphere supplied by GSFC. This comparison procedure transfers the radiation scale used by SBRC to calibrate the SeaWiFS instrument to the GSFC sphere. The GSFC sphere will be maintained as a reference scale to which the individual laboratories can relate. Direct comparisons of the radiance output of the GSFC sphere and the SBRC sphere were made.

Additional experiments involved the comparison of irradiance standard lamps from SBRC and GSFC, as well as absolute detector measurements conducted by J. Mueller and C. Titus. The personnel and test equipment involved were as follows:

GSFC

Personnel: J. McLean, J. Cooper, and R. Barnes.
Sphere: 107 cm diameter with 16–45 lamps.
Spectrometer: Optronic 746 with a 350–1,000 nm range in 5 nm steps.

SBRC

Personnel: L. Fulton and F. Domingue.
Sphere: 100 cm diameter with lamp level designation N_5 – N_{45} – N_{200} , where, N_5 , N_{45} , and N_{200} are the number of 5 W, 45 W, and 200 W lamps, respectively.

Spectrometer: A modified Cary 14 with a 380–940 nm range in 20 nm steps.

CHORS

Personnel: J. Mueller, C. Titus, and R. Austin.

A matrix of tests performed was established by GSFC and SBRC personnel and is shown in Table B1.

System Setup and Calibration

Functional checks were made on the Optronics 746 spectroradiometer system, which was initially configured with an ISIC. This included visual inspection for damage during shipping and handling. Some connections and circuit boards inside the radiometer’s electronic control unit were loose. Repairs were made and the system calibration test proceeded.

The system calibration procedure involves using an irradiance standard lamp to establish instrument irradiance response constants. This procedure transfers the standard lamp calibration values to the spectrometer. Fig. B1 shows the setup for this test. The radiance of the 42-inch sphere is determined by comparing the irradiance of the standard lamp at 50 cm from the spectrometer, to the irradiance produced by the radiance of the aperture of the integrating sphere at some selected distance (66.6 cm in this case). The setup for the laboratory is shown in Fig. B2.

Fig. B3 shows the irradiance calculation geometry. The radiance is then calculated from the equation:

$$E(\lambda) = \frac{\pi r_1^2}{d^2 + r_1^2 + r_2^2} L(\lambda) \quad (B1)$$

where $E(\lambda)$ is the spectral irradiance, $L(\lambda)$ is the spectral radiance, r_1^2 is the radius of source aperture, r_2^2 is the radius of detector aperture, and d is the distance between the two apertures.

The radiance values obtained at SBRC are given in Table B2. Also shown are calibration values acquired at GSFC just prior to the SBRC trip.

Calibration of SBRC Sphere by GSFC Techniques

The SBRC sphere (with a 100 cm diameter) was calibrated using the 746/ISIC at the 0–0–11 and 0–0–5 levels (see above for nomenclature) over the spectral range of 350–1,000 nm in 5 nm steps with a spectral bandpass of 4 nm. The laboratory setup was the same as shown in Fig. B2 with the SBRC sphere replacing the GSFC sphere. The distance was set to 78.3 cm to allow the viewing geometry to be the same as used with the GSFC sphere.

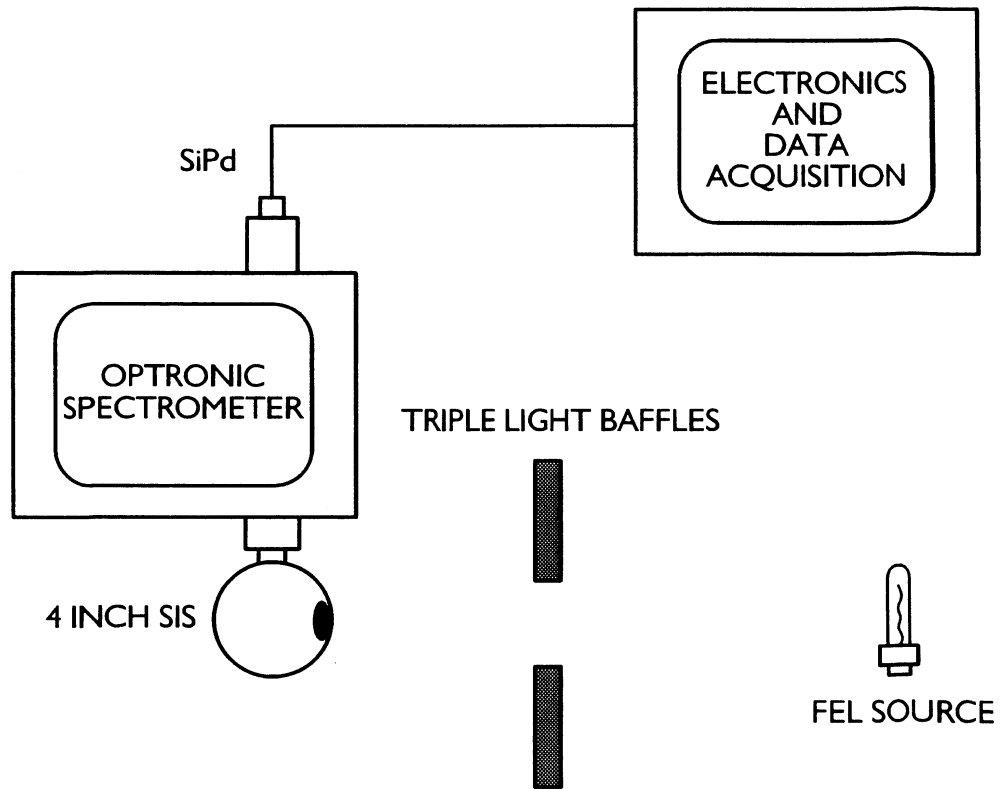

Fig. B1. System calibration test setup.

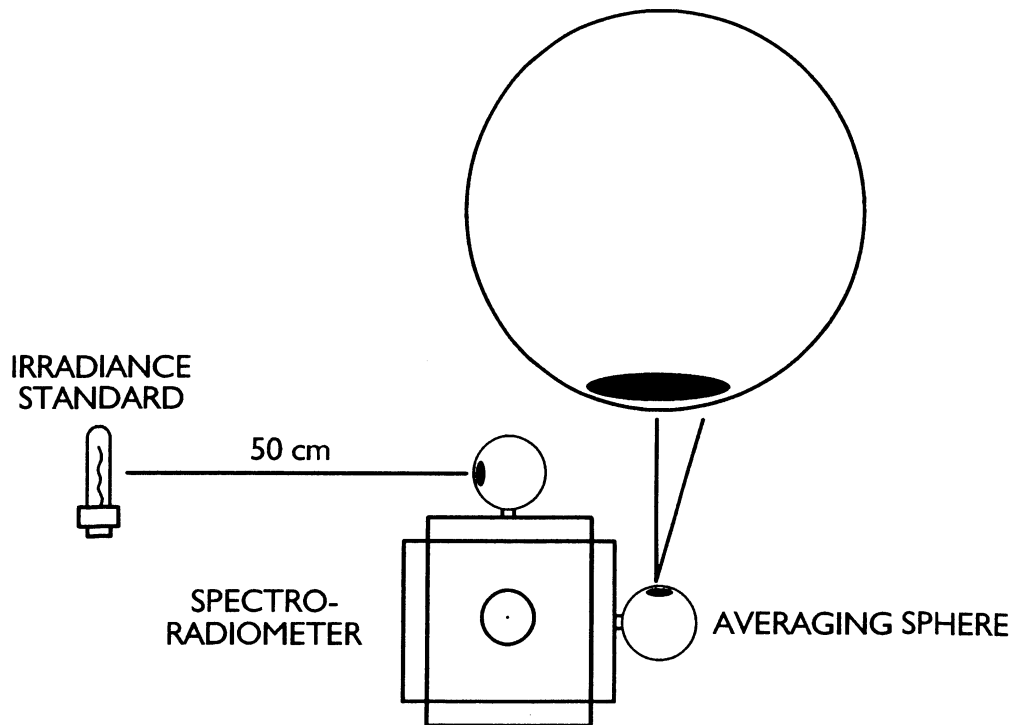

Fig. B2. Sphere calibration setup (GSFC).

Table B1. A matrix of equipment and tests involved in SIRREX-1.

Sources					Transfer	Test	Data
1	2	3	4	5	Radiometers	Configuration	Format
	×	×	×		SBRC Modified Cary 14 (with halon plate)	350–1,000 nm, $\Delta\lambda=20$ nm	Detector Output and Radiance Hard Copy
			×	×	CHORS QED Radiometer	10 Discrete filters (no information)	ASCII MS/DOS
×	×	×	×	×	GSFC 746 (with input sphere)	350–1,000 nm, $\Delta\lambda=5$ nm Irradiance Transfer	Irradiance ($\mu\text{W cm}^{-2} \text{ nm}^{-1}$) ASCII MS/DOS
			×	×	GSFC 746 (with telescope)	350–1,000 nm, $\Delta\lambda=5$ nm Radiance Transfer	Radiance ($\mu\text{W cm}^{-2} \text{ nm}^{-1} \text{ sr}^{-1}$) ASCII MS/DOS

Sources: 1=FEL source for system calibration; 2=FEL irradiance source; 3=DXW lamp viewed directly; 4=GSFC 42-inch sphere; and 5=SBRC SIS(100) sphere.

Table B2. Comparison of 42-inch sphere calibration values. All dates are for 1992.

λ [nm]	7 July	14 Oct.	27 Oct.	Average	% Diff.
380	1.901		2.042	1.972	5.0572
400	2.841	2.849	2.894	2.861	0.9985
420	4.237	4.292	4.250	4.260	0.6748
440	5.879	5.845	5.894	5.873	0.4275
460	7.774	7.651	7.759	7.728	0.8683
480	9.893	9.731	9.821	9.815	0.8270
500	12.246	11.960	12.030	12.079	1.2343
520	14.642	14.410	14.540	14.531	0.8002
540	17.172	16.980	17.050	17.067	0.5693
560	19.595	19.510	19.620	19.575	0.2946
580	22.168	22.090	22.220	22.159	0.2953
600	24.715	24.630	24.630	24.658	0.1990
620	27.407	26.840	27.080	27.109	1.0499
640	29.775	29.130	29.400	29.435	1.1005
660	31.847	31.320	31.630	31.599	0.8382
680	33.947	33.350	33.780	33.692	0.9142
700	36.114	35.360	35.700	35.725	1.0570
720	37.837	37.050	37.360	37.416	1.0596
740	39.527	38.640	39.170	39.112	1.1411
760	40.592	39.720	40.050	40.121	1.0974
780	42.220	41.330	41.700	41.750	1.0709
800	43.228	42.550	42.700	42.826	0.8316
820	43.998	43.370	43.500	43.623	0.7599
840	44.802	44.180	43.990	44.324	0.9582
860	45.216	44.700	44.390	44.769	0.9320
880	45.474	45.120	44.770	45.121	0.7801
900	45.486	45.160	44.650	45.099	0.9343
920	45.480	45.340	44.670	45.163	0.9586
940	44.839	44.890	44.160	44.630	0.9132
960	44.866	44.960	44.030	44.619	1.1474
980	44.794	44.780	43.850	44.475	1.2165
1000	44.485	44.380	43.760	44.208	0.8863

The SBRC sphere was reset to the 0–0–11 level. Radiance values were measured at four wavelengths: 450 nm, 550 nm, 650 nm, and 750 nm for lamp levels 0–0–11, 0–0–10, 0–0–9, 0–0–8, 0–0–7, 0–0–6, 0–0–5, 0–0–4, 0–0–3, 0–0–2, and 0–0–1. The results of these measurements are given in Tables B3 and B4.

Irradiance Standard Measurement by GSFC

The SBRC irradiance standard (SS27), a 1,000 W DXW-type quartz halogen lamp, was measured using the 746/ISIC in the same lab setup configuration (Fig. B1). The lamp-to-collector aperture distance was 110 cm. The data obtained in

the first test was repeated the following morning. Care was taken to reduce stray light, to verify the distance, and to recalibrate the spectral radiometer (746/ISIC). The results are listed in Table B5 and illustrated in Fig. B4.

Table B3. SBRC sphere (200 W lamps) radiances in $\mu\text{W cm}^{-2} \text{ nm}^{-1} \text{ sr}^{-1}$.

λ [nm]	Number of Lamps		λ [nm]	Number of Lamps	
	11	5		11	5
380	5.124	2.355	700	80.445	37.068
400	7.465	3.453	720	84.028	38.729
420	10.176	4.758	740	87.380	40.208
440	13.996	6.464	760	89.087	40.980
460	18.115	8.377	780	91.472	42.166
480	22.767	10.522	800	93.023	42.783
500	28.018	12.933	820	93.710	43.107
520	33.457	15.533	840	94.567	43.326
540	39.115	18.203	860	94.836	43.504
560	44.902	20.834	880	94.931	43.594
580	50.453	23.523	900	94.991	43.741
600	55.988	26.002	920	95.253	43.842
620	61.680	28.405	940	94.876	43.736
640	66.822	30.793	960	95.036	43.860
660	71.645	33.004	980	95.414	43.958
680	76.138	35.158	1000	95.982	44.141

Calibration of the GSFC Sphere by SBRC Techniques

SBRC personnel calibrated the GSFC sphere using lamp SS27 and the Cary 14 spectrophotometer (see Fig. B5). The technique used consists of comparing the calculated radiance reflected from a halon plate illuminated by SBRC lamp SS27 to the radiance of the aperture of the integrating sphere. The results of that calibration are given in Table B6.

Fig. B6 shows that the SBRC measured values are about 10% smaller than those obtained by GSFC. (Note: the SBRC sphere was not recalibrated during this intercomparison.)

Calibration of GSFC Lamp F269 by SBRC Techniques

The laboratory measurement setup was configured as shown in Fig. B7. A test consists of the following sequence of steps:

1. The Cary 14 system essentially stops at one wavelength and records 10 samples.
2. The average and standard deviation are computed and then recorded for a given source.
3. A rotatable mirror directs the output of the unknown source into the Cary 14 system.

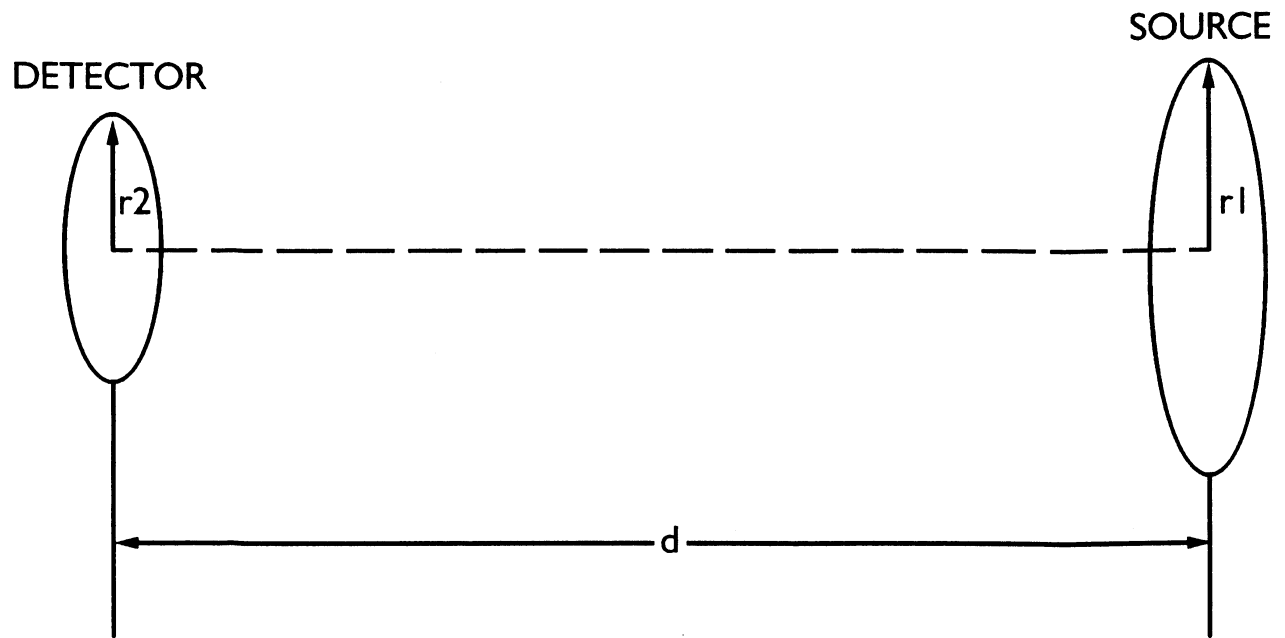

Fig. B3. Irradiance calibration geometry.

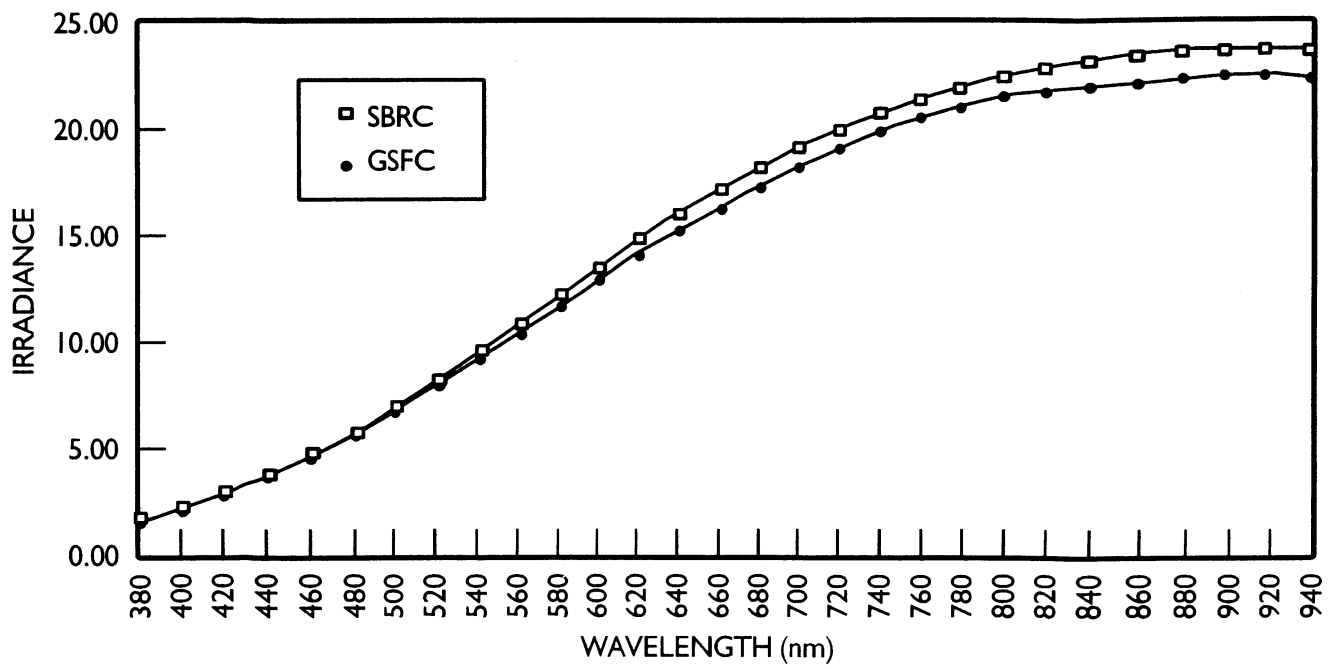

Fig. B4. Lamp SS27 irradiance at 50 cm.

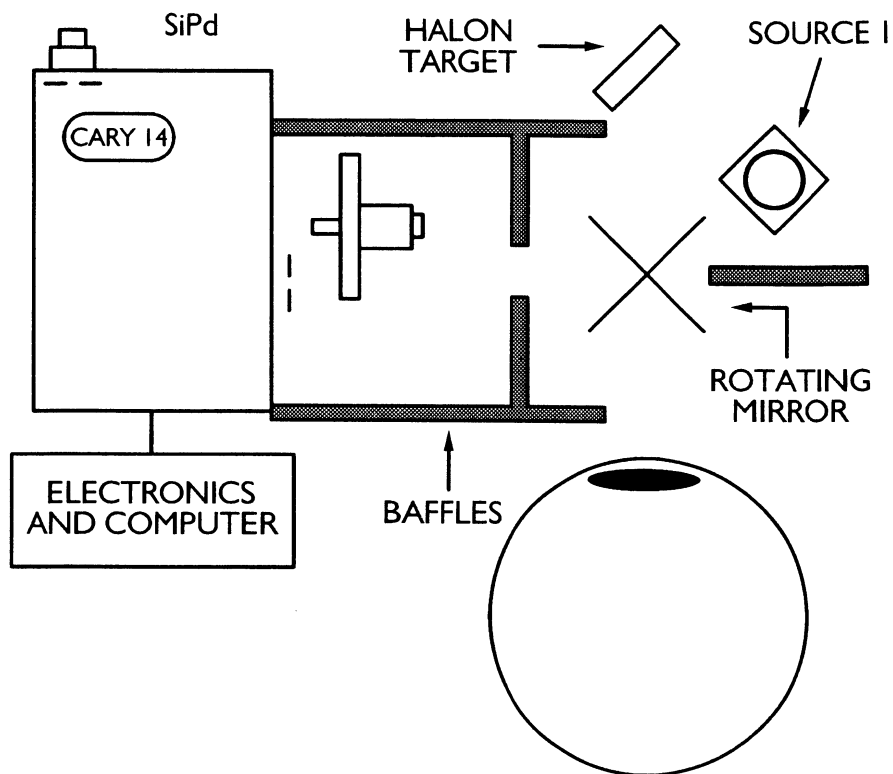

Fig. B5. Sphere calibration setup (SBRC).

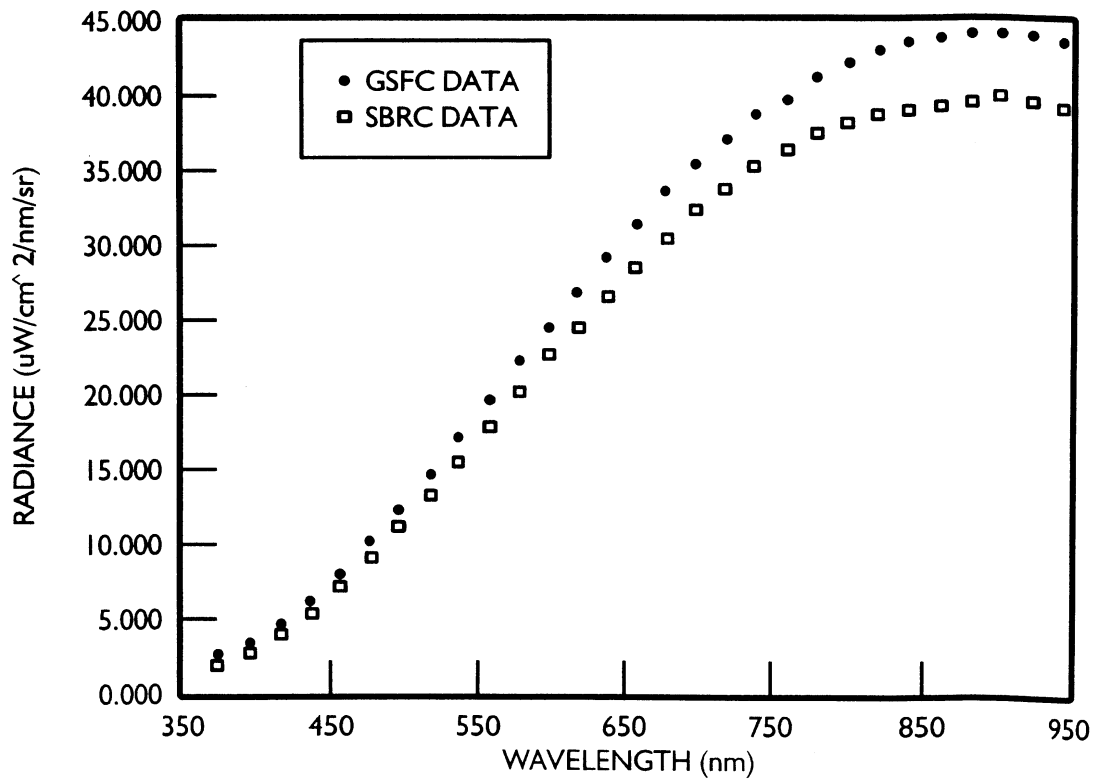

Fig. B6. Radiance of GSFC sphere at SBRC.

Table B4. SBRC sphere radiance comparison at selected wavelengths in units of $\mu\text{W cm}^{-2} \text{ nm}^{-1} \text{ sr}^{-1}$.

λ [nm]	Measurement	Lamp Level (Number of 200 W Lamps On)										
		11	10	9	8	7	6	5	4	3	2	1
450	GSFC	15.880	14.319	13.055	11.661	10.320	8.785	7.327	5.766	4.403	2.891	1.441
	SBRC	16.070	14.500	13.115	11.835	10.376	8.906	7.406	5.922	4.430	2.907	1.435
	Ratio	0.988	0.987	0.995	0.985	0.995	0.986	0.989	0.974	0.994	0.994	1.004
550	GSFC	41.799	37.731	34.141	30.791	27.034	23.173	19.312	15.340	11.471	7.562	3.725
	SBRC	41.275	37.310	33.570	30.280	26.545	22.790	18.980	15.155	11.335	7.459	3.692
	Ratio	1.013	1.011	1.017	1.017	1.018	1.017	1.017	1.012	1.012	1.014	1.009
650	GSFC	68.847	62.397	56.508	50.619	44.309	37.859	31.479	25.309	18.859	12.451	6.128
	SBRC	68.270	61.785	55.545	49.965	43.860	37.595	31.310	25.025	18.740	12.340	6.099
	Ratio	1.008	1.010	1.017	1.013	1.010	1.007	1.005	1.011	1.006	1.009	1.005
750	GSFC	88.374	80.008	72.223	64.686	56.486	48.452	40.418	32.136	24.152	15.927	7.860
	SBRC	87.330	79.070	71.055	63.810	55.945	48.000	40.000	31.955	23.905	15.795	7.802
	Ratio	1.012	1.012	1.016	1.014	1.010	1.009	1.010	1.006	1.010	1.008	1.007
Average of Ratios		1.005	1.005	1.012	1.007	1.008	1.005	1.006	1.001	1.006	1.006	1.006
Standard Deviation		0.010	0.010	0.009	0.013	0.009	0.011	0.010	0.016	0.007	0.007	0.002

Table B5. SBRC DXW lamp SS27 irradiance at 50 cm in units of $\mu\text{W cm}^{-2} \text{ nm}^{-1}$.

λ [nm]	Baffled		Unbaffled		Average Irradiance	Precision [%]	λ [nm]	Baffled		Unbaffled		Average Irradiance	Precision [%]
	27 Oct.	28 Oct.	28 Oct.	28 Oct.				27 Oct.	28 Oct.	28 Oct.	28 Oct.		
380	1.54	1.64	1.39	1.53	0.0682	700	18.94	19.04	18.96	18.98	0.0022		
400	2.10	2.14	2.05	2.10	0.0187	720	19.74	19.90	19.82	19.82	0.0033		
420	2.76	2.94	2.76	2.82	0.0307	740	20.53	20.67	20.61	20.61	0.0029		
440	3.63	3.70	3.64	3.66	0.0087	760	21.13	21.30	21.21	21.21	0.0032		
460	4.62	4.64	4.66	4.64	0.0035	780	21.67	21.82	21.84	21.78	0.0035		
480	5.70	5.79	5.77	5.75	0.0068	800	22.20	22.36	22.33	22.30	0.0031		
500	6.98	6.97	6.97	6.97	0.0008	820	22.63	22.78	22.80	22.74	0.0034		
520	8.21	8.24	8.21	8.22	0.0015	840	22.97	23.07	23.03	23.02	0.0017		
540	9.56	9.56	9.52	9.54	0.0020	860	23.17	23.32	23.32	23.27	0.0030		
560	10.79	10.88	10.84	10.84	0.0034	880	23.32	23.52	23.48	23.44	0.0036		
580	12.10	12.21	12.16	12.16	0.0038	900	23.47	23.55	23.54	23.52	0.0016		
600	13.39	13.44	13.37	13.40	0.0022	920	23.49	23.62	23.56	23.56	0.0022		
620	14.65	14.75	14.71	14.70	0.0027	940	23.45	23.55	23.55	23.52	0.0022		
640	15.84	15.90	15.89	15.88	0.0016	960	23.36	23.49	23.51	23.45	0.0029		
660	17.01	17.06	16.98	17.01	0.0019	980	23.18	23.44	23.42	23.34	0.0051		
680	18.01	18.11	18.02	18.05	0.0024	1000	23.02	23.31	23.30	23.21	0.0058		

Table B6. Radiance of GSFC sphere (SBRC measurement) in units of $\mu\text{W cm}^{-2} \text{ nm}^{-1} \text{ sr}^{-1}$.

λ [nm]	Data Source:		λ [nm]	Data Source:	
	GSFC	SBRC		GSFC	SBRC
380	2.040	1.309	680	33.780	30.630
400	2.894	2.142	700	35.700	32.510
420	4.250	3.398	720	37.360	34.000
440	5.894	4.883	740	39.170	35.570
460	7.759	6.735	760	40.050	36.760
480	9.821	8.781	780	41.700	37.710
500	12.030	10.820	800	42.700	38.540
520	14.540	13.040	820	43.500	39.150
540	17.050	15.250	840	43.990	39.480
560	19.620	17.640	860	44.390	39.720
580	22.220	20.060	880	44.770	40.080
600	24.630	22.500	900	44.650	40.410
620	27.080	24.630	920	44.670	40.150
640	29.400	26.770	940	44.160	39.740
660	31.630	28.770			

- The data for the unknown source is then recorded.
- This process continues until the chosen wavelength range has been scanned.

The results of this test are given in Table B7, and the plot in Fig. B8 compares two SBRC measurements to the irradiance scale of F269 as calibrated by NIST in October 1992. The laboratory setup for this test was done in a hurried, makeshift arrangement and the SBRC measurements are not necessarily reliable in this instance.

Relative Radiance Checks Using the 746 with Telescope

The reflex telescope replaced the ISIC on the 746 and was used to scan both the SBRC and GSFC spheres. The 746/T laboratory setup is shown in Fig. B9. The telescope focus was set at infinity (defocused) and the distance was 141 cm for the GSFC sphere and 145 cm for the SBRC sphere. The field-of-view was 1.5° . Scans were made from 350–1,000 nm in steps of 5 nm. Output levels 0–0–11, 0–0–5, 0–0–3, 6–2–0, and 0–0–1 were measured on the SBRC sphere. The GSFC sphere was measured with all 16 lamps lit. This level is roughly equivalent

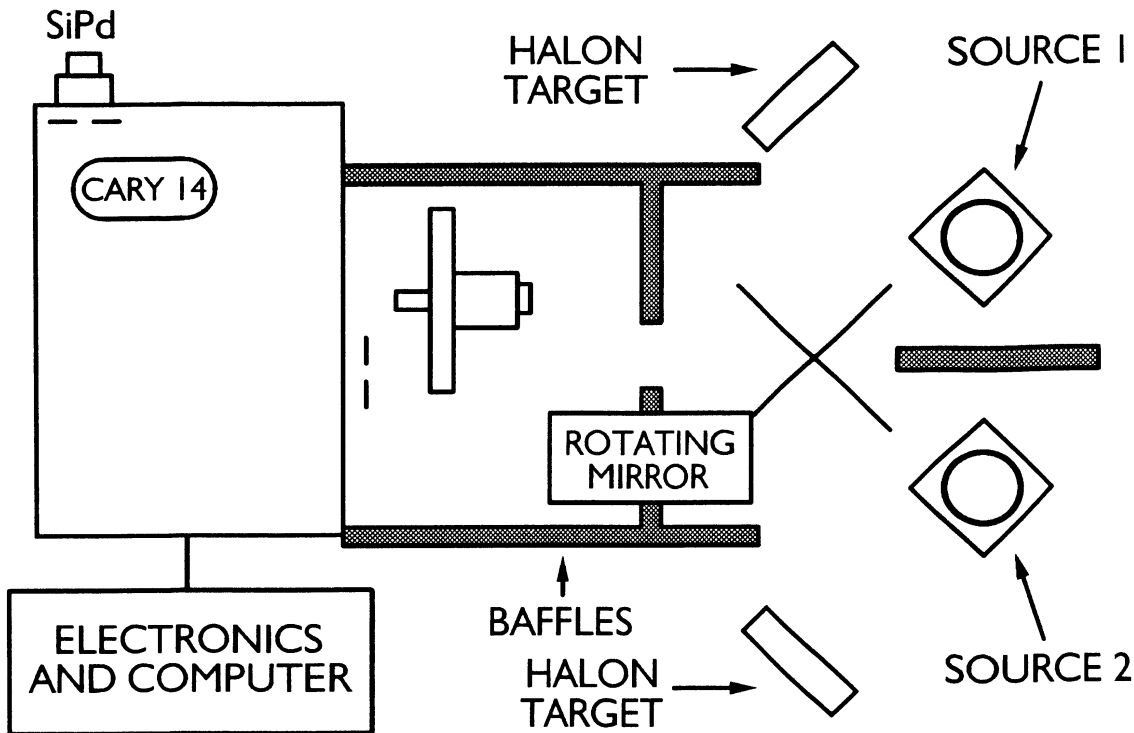

Fig. B7. Lamp calibration setup (SBRC).

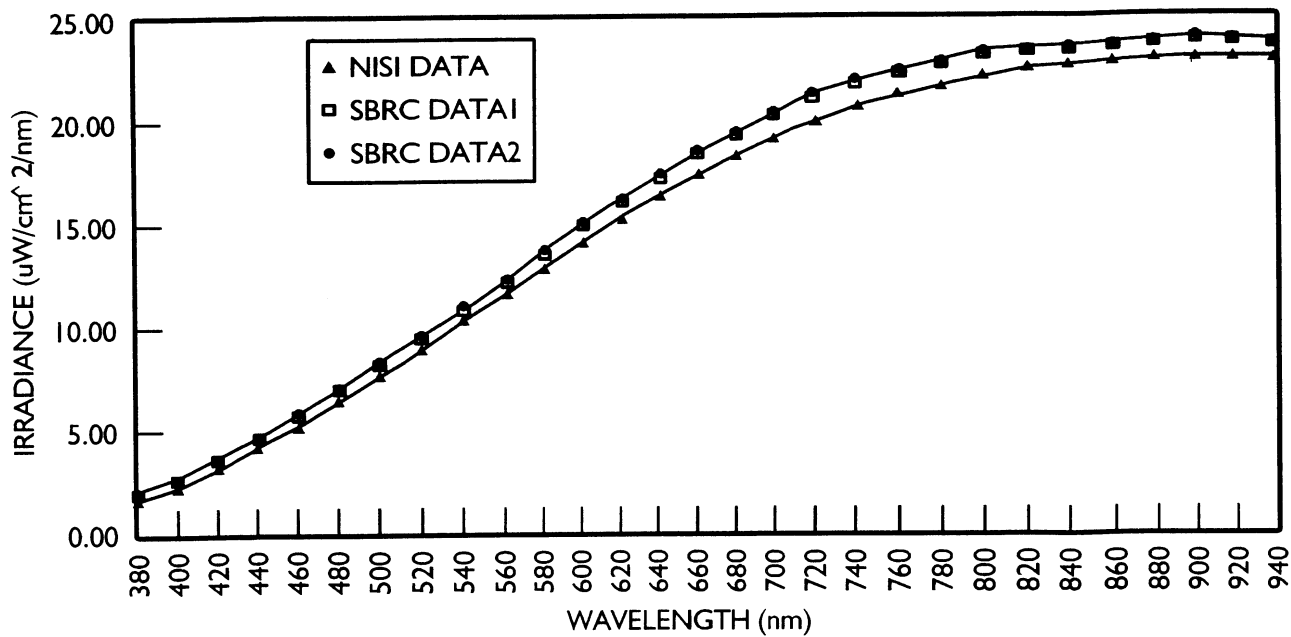

Fig. B8. Irradiance measurements of lamp F269.

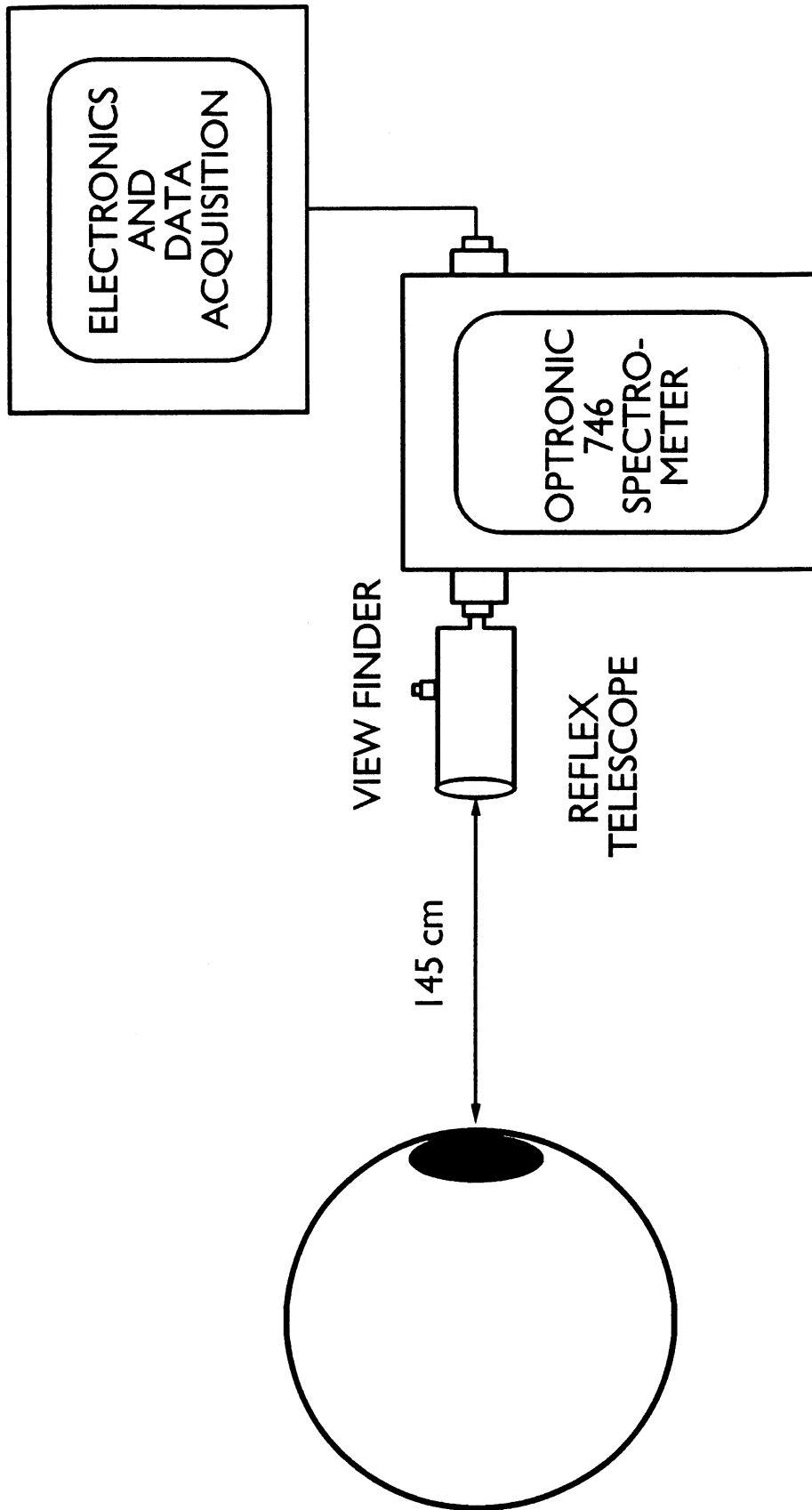

Fig. B9. Sphere calibration, spectroradiometer with telescope, setup.

Table B7. Irradiance lamp F269 calibrated at SBRC in units of $\mu\text{W cm}^{-2} \text{ nm}^{-1}$.

λ [nm]	SBRC			Ratio of SBRC/NIST	λ [nm]	SBRC			Ratio of SBRC/NIST
	NIST Data	Data1	Data2			Data	Data1	Data2	
380	1.653	1.921	1.937	1.162	680	18.410	19.406	19.528	1.054
400	2.341	2.616	2.678	1.117	700	19.300	20.380	20.502	1.056
420	3.179	3.607	3.679	1.134	720	20.080	21.124	21.237	1.052
440	4.142	4.584	4.653	1.107	740	20.760	21.878	21.988	1.054
460	5.219	5.671	5.781	1.087	760	21.350	22.447	22.563	1.051
480	6.394	6.943	7.015	1.086	780	21.850	22.887	22.996	1.047
500	7.638	8.178	8.291	1.071	800	22.270	23.352	23.452	1.049
520	8.928	9.535	9.651	1.068	820	22.600	23.487	23.597	1.039
560	11.560	12.205	12.353	1.056	840	22.860	23.609	23.703	1.033
580	12.850	13.628	13.738	1.061	860	23.040	23.728	23.813	1.030
600	14.100	15.014	15.146	1.065	880	23.160	23.879	23.955	1.031
620	15.280	16.192	16.314	1.060	900	23.210	24.077	24.134	1.037
640	16.400	17.348	17.489	1.058	920	23.200	23.933	23.983	1.032
660	17.450	18.425	18.561	1.056	940	23.130	23.848	23.889	1.031

Table B8. SBRC sphere measurements from October 1992 using the 746 with telescope optics. Values are in units of $\mu\text{W cm}^{-2} \text{ nm}^{-1} \text{ sr}^{-1}$.

λ [nm]	200 W Lamps			Six 5 W and		λ [nm]	200 W Lamps			Six 5 W and	
	11	5	3	Two 45 W	One 45 W		11	5	3	Two 45 W	One 45 W
380	5.510	2.549	1.522	0.274	0.134	700	83.976	38.264	23.004	4.334	1.967
400	7.544	3.478	2.067	0.374	0.180	720	87.926	40.074	24.086	4.542	2.058
420	10.559	4.878	2.895	0.527	0.251	740	91.584	41.766	25.087	4.750	2.147
440	14.435	6.637	3.959	0.719	0.342	760	93.261	42.653	25.537	4.841	2.182
460	18.781	8.636	5.131	0.935	0.441	780	96.080	43.766	26.304	4.996	2.249
480	23.643	10.878	6.459	1.183	0.555	800	97.520	44.458	26.690	5.083	2.280
500	28.715	13.255	7.886	1.447	0.678	820	98.454	44.844	26.923	5.125	2.298
520	34.520	15.973	9.502	1.751	0.816	840	98.636	44.919	27.002	5.143	2.303
540	40.500	18.685	11.126	2.053	0.954	860	99.183	45.201	27.137	5.187	2.310
560	46.535	21.451	12.767	2.369	1.096	880	99.775	45.456	27.304	5.226	2.326
580	52.510	24.244	14.432	2.684	1.238	900	99.748	45.366	27.248	5.238	2.321
600	59.159	27.042	16.225	3.007	1.387	920	100.160	45.558	27.129	5.261	2.329
620	64.526	29.421	17.658	3.293	1.512	940	99.644	45.392	26.990	5.248	2.323
640	69.771	31.776	19.122	3.573	1.635	960	99.465	45.248	26.905	5.245	2.313
660	74.818	34.083	20.485	3.840	1.753	980	99.264	45.133	26.851	5.242	2.307
680	79.640	36.344	21.855	4.104	1.867	1000	99.956	45.457	26.967	5.280	2.324

to the 0–0–5 level of the SBRC sphere. The data given in Table B8 is considered relative radiance, since the use of the telescope in this transfer is still being evaluated.

CHORS QED Radiometer Measurements

CHORS personnel used a filtered radiometer to measure output of both the SBRC and GSFC spheres. The GSFC sphere was measured with 16 lamps lit, as well as with 4 lamps lit. The SBRC sphere was measured at five levels, namely: 0–0–11, 0–0–5, 0–0–3, 6–2–0, and 0–0–1. The raw data obtained is given in Table B9. Spectral calibration constants for the CHORS radiometer have not yet been made available.

Observations and Conclusions

One of the purposes of SIRREX-1 was to determine and resolve any problem areas involved in relating data obtained by researchers making *in situ* optical measurements. These measurements have succeeded in pinpointing areas that need improvement. In summary, there is a need for:

- Well defined and controlled experimental techniques in measurements,
- An improvement in performance of laboratory and field optical measuring equipment,
- Independent means for verifying the validity of each measurement procedure and results, and
- Real-time assessment of critical test results (tests with results that influence subsequent measurements or analyses).

The tests at SBRC provided instances of data which was consistent with SBRC's results, as well as data which was inconsistent:

- The GSFC measurement of the SBRC sphere produced values that agreed with SBRC data to within 2–3%.
- The SBRC measurement of the GSFC sphere differed by about 10% (below) with respect to the GSFC data.

Table B9. CHORS QED filter radiometer (output in volts).

Filter No.	GSFC				SBRC				
	16 Lamps ¹	16 Lamps ²	4 Lamps	4 Gain 10	0-0-11	0-0-5	0-0-3	6-2-0	0-1-0
f_0	-0.003517	-0.003466	-0.000908	-0.008741	-0.009387	-0.004367	-0.002638	-0.005041	-0.002586
f_1	-1.168189	-1.168254	-1.168186	-1.167163	-1.168203	-1.168187	-1.168189	-1.167153	-1.167231
f_2	-0.196693	-0.203744	-0.048600	-0.498981	-0.468297	-0.213149	-0.125810	-0.245612	-0.112980
f_3	-0.135841	-0.140254	-0.034848	-0.350364	-0.326341	-0.149405	-0.090253	-0.169211	-0.077407
f_4	-0.081303	-0.083192	-0.020943	-0.191009	-0.193980	-0.091559	-0.054962	-0.102837	-0.041497
f_5	-0.075136	-0.078216	-0.019542	-0.196656	-0.183058	-0.086134	-0.049347	-0.096849	-0.044247
f_6	-0.067072	-0.070157	-0.017220	-0.167580	-0.165884	-0.076129	-0.045552	-0.084676	-0.040100
f_7	-0.046341	-0.050157	-0.012283	-0.124569	-0.118150	-0.055241	-0.033016	-0.061248	-0.028088
f_8	-0.028182	-0.029460	-0.007285	-0.073411	-0.069386	-0.032618	-0.019477	-0.035893	-0.016343
f_9	-0.019709	-0.020510	-0.005033	-0.050783	-0.048354	-0.022554	-0.013501	-0.025229	-0.011645
f_{10}	-0.038875	-0.061576	-0.011572	-0.122711	-0.141077	-0.058019	-0.034322	-0.051110	-0.029186
f_{11}	-0.008850	-0.009195	-0.002211	-0.022232	-0.022494	-0.010359	-0.006191	-0.011129	-0.005891
f_0	-0.003500	-0.003597	-0.000906	-0.009141	-0.009433	-0.004385	-0.002623	-0.005053	-0.002811
f_1	-1.168188	-1.168224		-1.167169	-1.168204	-1.168164	-1.168192	-1.167165	-1.167018
f_2	-0.196787	-0.204084		-0.492756	-0.468861	-0.213136	-0.125907	-0.244585	-0.112142
f_3	-0.135833	-0.140717		-0.349807	-0.326169	-0.151141	-0.090757	-0.169857	-0.078108
f_4	-0.081377	-0.084890		-0.210041	-0.198057	-0.091898	-0.054879	-0.103036	-0.047446
f_5	-0.074915	-0.078120		-0.196930	-0.164220	-0.086245	-0.049909	-0.096560	-0.043978
f_6	-0.066952	-0.070085		-0.173530	-0.164150	-0.076202	-0.045450	-0.085150	-0.039159
f_7	-0.048395	-0.048747		-0.124690	-0.118042	-0.055256	-0.032975	-0.060531	-0.025334
f_8	-0.028377	-0.029483		-0.073148	-0.069348	-0.032631	-0.019420	-0.036220	-0.016340
f_9	-0.019722	-0.020397		-0.050601	-0.048648	-0.022568	-0.013565	-0.024896	-0.011099
f_{10}	-0.039295	-0.041515		-0.128689	-0.096752	-0.056662	-0.029032	-0.062016	-0.023348
f_{11}	-0.008845	-0.009222		-0.022356	-0.022397	-0.010379	-0.006170	-0.011292	-0.005856
f_0	-0.003444	-0.004081		-0.009127	-0.009362	-0.004386		-0.005070	-0.002769
f_1					-1.168182	-1.168172			-1.166920

1 = Run number 1.

2 = Run number 2.

- The GSFC measurement of the SBRC lamp produced values higher than the values furnished by SBRC.
- The SBRC measurement of the GSFC (NIST) lamp produced higher values than those furnished by NIST.

Appendix C

Intercalibration Data Archive

SIRREX activities are being recorded using the Sybase relational database utility on the Calibration/Validation UNIX workstation (CALVAL) at GSFC. A duplicate database has also been implemented on a 486 PC (WIFS) using the FoxPro database package. The SIRREX database provides a means of ensuring data integrity and availability. The database is designed to hold descriptive data (meta-data) on calibration files and accompanying notes obtained during SIRREX activities. The actual calibration data and the additional descriptive text are stored in on-line ASCII files outside the database on both CALVAL and WIFS within identical directory structures. The information stored within the database is used to locate and describe these intercalibration files.

The database layout was implemented using a two-table design for storing the meta-data. General information on the SIRREX data sets are provided in the *data set* table, and specific information on the data are provided in the *data* table. Both tables use the *data_set* field as the primary key for accessing the meta-data. Tables C1 and C2 show the design of

the database tables along with typical entries for the data set fields (columns). Information was stored in either text (character) format or integer format. Blanks may appear in the table for columns in which NULL ALLOWED is set to YES. The *DATA_SET_DESC* field in the *DATA_SET* table provides the name of on-line ASCII files that contain additional descriptive information. The following text is the contents of the descriptive ASCII file referenced in Table C1:

Irradiance file for Hoffman 90572 lamp obtained on the second day at the first SeaWiFS round robin lamp intercomparison trials at CHORS. Lamp modes are shown in the *radiometric_source* column in the "data" table. Data in ~/cooper3/pp08-15.

Routines for accessing the meta-data in the SIRREX database on CALVAL have been implemented using the Sequential Query Language (SQL). With these routines, it is possible to obtain information on a file, information on the data within the file, or both. Plans have been made to link the database with the Interactive Data Language (IDL) thus providing a graphical user interface and a means for analyzing and displaying the data. This implementation will also provide a more robust scheme for selecting information. A link between the database and IDL has been successfully implemented for other applications on CALVAL.

Table C1. Design of the *data set* table.

<i>Column</i>	<i>Data Type</i>	<i>Nulls Allowed</i>	<i>Example Entry</i>
DATA_SET	character	NO	ir90572a.dat
DATA_SET_DESC	character	NO	ir90572a.meta
ORIGINAL_NAME	character	YES	ir90572a.dat
SOURCE	character	YES	NASA

Table C2. Design of the *data* table.

<i>Field</i>	<i>Data Type</i>	<i>Nulls Allowed</i>	<i>Example Entry</i>
DATA_SET	character	NO	ir90572a.dat
DATA	character	NO	Irradiance
DATA_DESC	character	NO	Irradiance as a function of wavelength
FORMAT	character	NO	ASCII
UNITS	character	NO	W/cm2nm
LOCATION	character	YES	Santa Barbara, CA
DATE	character	YES	7/31/92
IDATE	integer	YES	920731
TIME	character	YES	1055
INVESTIGATOR	character	YES	J. Cooper, J. McLean
RADIOMETRIC_SOU	character	YES	Irradiance lamp standard-Hoffman 90572
INSTRUMENT	character	YES	746 monochrometer system
CAL_SOURCE	character	YES	NULL
PROCESS_LEVEL	integer	YES	0
SPECTRAL_RES	character	YES	400nm to 750nm at 5nm intervals
BANDPASS	character	YES	2nm
DATA_TYPE	character	YES	Lamp

Appendix D*Attendees to SIRREX-1*

Gregg Adelman
 Biospherical Instruments
 5340 Riley Street
 San Diego, CA 92110
 Voice: 602-686-1888
 Fax: 602-686-1887

Ros Austin
 SDSU/CHORS/Suite 206
 6505 Alvarado Road
 San Diego, CA 92120-5005
 Voice: 619-594-2244
 Fax: 619-594-4570
 Internet: raustin@chors.sdsu.edu

Rocky Booth
 Biospherical Instruments
 5340 Riley Street
 San Diego, CA 92110
 Voice: 602-686-1888
 Fax: 602-686-1887
 Internet: booth@ssurf.ucsd.edu

Bill Broenkow
 Moss Landing Marine Laboratory
 PO Box 450
 Moss Landing, CA 95039
 Voice: 408-755-8675
 Fax: 408-755-8686

Dennis Clark
 NOAA/NESDIS
 E/RA 28, WWB, Rm. 104
 Washington, DC 20233
 Voice: 301-763-8102
 Fax: 301-763-8020
 Omnet: d.clark.noaa

John Cooper
 NASA/GSFC/Code 925
 Greenbelt, MD 20771
 Voice: 301-286-1210
 Fax: 301-286-1616
 Internet: cooper@toms.dnet.gsfc.nasa.gov

Chris Cromer
 NIST/Bldg. 221, Room A221
 Gaithersburg, MD 20899
 Voice: 301-975-3216
 Fax: 301-840-8551
 Internet: cromer@garnet.nist.gov

Mike Feinholz
 Moss Landing Marine Laboratory
 PO Box 450
 Moss Landing, CA 95039
 Voice: 408-755-8675
 Fax: 408-753-2826
 Internet: feinholz@nsf.mlml.sdsu.calstate.edu

Dave Goebel
 Sigma Research Technologies, Inc.
 1851 Woodbine Ct.
 Marco Island, FL 33937
 Voice: 813-394-9138

Bob Howarth
NCCOSC/NRaD/Code 844
271 Catalina Blvd.
San Diego, CA 92152
Voice: 619-553-3717
Lab: 619-553-5189

Carol Johnson
NIST/Bldg. 221, Room A221
Gaithersburg, MD 20899
Voice: 301-975-2322
Fax: 301-840-8551
Internet: cjohnson@enh.nist.gov

Richard Johnson
UCSD/MPL/Mail Code 0701
9500 Gilman Drive
La Jolla, CA 92093-0701
Voice: 619-534-1772
Fax: 619-553-0764
Internet: monette@mpl.ucsd.edu

Jim McLean
NASA/GSFC/Code 925
Greenbelt, MD 20771
Voice: 301-286-8134
Fax: 301-286-1616
GSFCmail: jmclean

Scott McLean
Satlantic Inc.
Richmond Terminal Pier 9
3295 Barrington Street
Halifax, B3K5X8
Nova Scotia
Voice: 902-492-4780
Fax: 902-492-4781
Internet: scott@predator.ocean.dal.ca

Dave Menzies
CRSEO/UCSB
Santa Barbara, CA 93106
Voice: 805-893-8496
Fax: 805-893-2578
Internet: davem@crseo.ucsb.edu

James Mueller
SDSU/CHORS/Suite 206
6505 Alvarado Road
San Diego, CA 92120-5005
Voice: 619-594-2230
Fax: 619-594-4570
Omnet: j.mueller
Internet: jmueller@chors.sdsu.edu

Raymond Smith
CRSEO/UCSB
Santa Barbara, CA 93106
Voice: 805-893-4709
Fax: 805-893-2578
Omnet: r.smith.ucsb
Internet: ray@crseo.ucsb.edu

Clay Titus
SDSU/CHORS/Suite 206
6505 Alvarado Road
San Diego, CA 92120-5005
Voice: 619-594-2244
Lab: 619-594-4830
Fax: 619-594-4570
Internet: ctitus@chors.sdsu.edu

Ken Voss
UM/Dept. of Physics
Coral Gables, FL 33124
Voice: 305-284-2323
Fax: 305-284-4222
Omnet: k.voss
Internet: kvoss@umiami.miami.edu

Mark Yarbrough
Moss Landing Marine Laboratory
PO Box 450
Moss Landing, CA 95039
Voice: 408-755-8685
Fax: 408-755-8686
Internet: yarbrough@nsf.mlml.sdsu.calstate.edu

GLOSSARY

- ASCII American Standard Code for Information Interchange
- BRDF Bidirectional Reflectance Distribution Function
- BSI Biospherical Instruments, Incorporated
- CALVAL Calibration and Validation
- CHORS Center for Hydro-Optics and Remote Sensing
- DXW Not an acronym, but a lamp designator.
- FASCAL Fast Calibration (Facility)
- FEL Not an acronym, but a lamp designator.
- GLOBEC Global Ecosystem
- GSFC Goddard Space Flight Center
- HEI Hoffman Engineering, Incorporated
- IBM International Business Machines
- IDL Interactive Data Language
- ISIC Integrating Sphere Irradiance Collector
- JGOFS Joint Global Ocean Flux Study
- MLML Moss Landing Marine Laboratory
- MOBY Marine Optical Buoy
- MS/DOS MicroSoft/Disk Operating System
- NASA National Aeronautics and Space Administration
- NCCOSC Navy Command, Control, and Ocean Surveillance Center
- NIST National Institute of Standards and Technology
- NOAA National Oceanic and Atmospheric Administration
- NRaD Naval Research and Development
- OI Original Irradiance
- PC (IBM) Personal Computer
- PDT Pacific Daylight Time
- PR Photo Research
- PST Pacific Standard Time
- RR Round-Robin

SBRC (Hughes) Santa Barbara Research Center
 SDSU San Diego State University
 SeaWiFS Sea-viewing Wide Field-of-view Sensor
 SIO/MPL Scripps Institution of Oceanography/Marine
 Physical Laboratory
 SIRREX SeaWiFS Intercalibration Round-Robin Experiment
 SIRREX-1 The First SIRREX (July 1992)
 SIS Spherical Integrating Source
 SJSU San Jose State University
 S/N Serial Number
 SQL Sequential Query Language
 SRT Sigma Research Technology, Incorporated
 UCSB University of California at Santa Barbara
 UM University of Miami
 VDC Volts Direct Current

SYMBOLS

d The distance between source and detector apertures.
 $E(\lambda)$ Spectral irradiance.
 E_{beg} Beginning irradiance value.
 E_{end} Ending irradiance value.
 f_i Filter number, $i=0-11$.
 $F(\lambda)$ A conversion factor to convert PR714 readings to
 the GSFC sphere radiance scale.
 $\bar{F}(\lambda)$ A mean conversion factor.
 $L(\lambda)$ Spectral radiance.
 $L_i(\lambda)$ Spectral radiance for run number i .
 r_1 The radius of source aperture.
 r_2 The radius of detector aperture.
 δ The departure of each individual conversion factor
 from the mean.
 $\Delta\lambda$ An interval in wavelength.
 λ Wavelength.

REFERENCES

Hooker, S.B., W.E. Esaias, G.C. Feldman, W.W. Gregg, and
 C.R. McClain, 1992: An Overview of SeaWiFS and Ocean
 Color. *NASA Tech. Memo. 104566, Vol. 1*, S.B. Hooker
 and E.R. Firestone, Eds., NASA Goddard Space Flight
 Center, Greenbelt, Maryland, 24 pp.
 McClain, C.R., W.E. Esaias, W. Barnes, B. Guenther, D. En-
 dres, S.B. Hooker, G. Mitchell, and R. Barnes, 1992: Cal-
 ibration and Validation Plan for SeaWiFS. *NASA Tech.
 Memo. 104566, Vol. 3*, S.B. Hooker and E.R. Firestone,
 Eds., NASA Goddard Space Flight Center, Greenbelt,
 Maryland, 41 pp.
 Mueller, J.L., and R.W. Austin, 1992: Ocean Optics Protocols
 for SeaWiFS Validation. *NASA Tech. Memo. 104566, Vol.
 5*, S.B. Hooker and E.R. Firestone, Eds., NASA Goddard
 Space Flight Center, Greenbelt, Maryland, 45 pp.
 Walker, J.H., R.D. Saunders, J.K. Jackson, and D.A. McSpar-
 ron, 1987: Spectral Irradiance Calibrations. *NBS Special Pub-
 lication 250-20*, U.S. Dept. of Commerce, National Bureau of
 Standards, Washington, D.C., 37 pp. plus appendices.

Vol. 1

Hooker, S.B., W.E. Esaias, G.C. Feldman, W.W. Gregg, and
 C.R. McClain, 1992: An Overview of SeaWiFS and Ocean
 Color. *NASA Tech. Memo. 104566, Vol. 1*, S.B. Hooker
 and E.R. Firestone, Eds., 24 pp.

Vol. 2

W. Gregg, 1992: Analysis of Orbit Selection for SeaWiFS:
 Ascending vs. Descending Node. *NASA Tech. Memo.
 104566, Vol. 2*, S.B. Hooker and E.R. Firestone, Eds.,
 16 pp.

Vol. 3

McClain, C.R., W.E. Esaias, W. Barnes, B. Guenther, D. En-
 dres, S. Hooker, G. Mitchell, and R. Barnes, 1992: Cal-
 ibration and Validation Plan for SeaWiFS. *NASA Tech.
 Memo. 104566, Vol. 3*, S.B. Hooker and E.R. Firestone,
 Eds., 41 pp.

Vol. 4

McClain, C.R., E. Yeh, and G. Fu, 1992: An Analysis of GAC
 Sampling Algorithms: A Case Study. *NASA Tech. Memo.
 104566, Vol. 4*, S.B. Hooker and E.R. Firestone, Eds.,
 22 pp.

Vol. 5

Mueller, J.L., and R.W. Austin, 1992: Ocean Optics Protocols.
NASA Tech. Memo. 104566, Vol. 5, S.B. Hooker and E.R.
 Firestone, Eds., 43 pp.

Vol. 6

Firestone, E.R., and S.B. Hooker, 1992: SeaWiFS Technical
 Report Series Summary Index: Volumes 1-5. *NASA Tech.
 Memo. 104566, Vol. 6*, S.B. Hooker and E.R. Firestone,
 Eds., 9 pp.

Vol. 7

Darzi, M., 1992: Cloud Screening for Polar Orbiting Visible
 and IR Satellite Sensors. *NASA Tech. Memo. 104566, Vol.
 7*, S.B. Hooker and E.R. Firestone, Eds., 7 pp.

Vol. 8

Hooker, S.B., W.E. Esaias, and L.A. Rexrode, 1993: Proceed-
 ings of the First SeaWiFS Science Team Meeting. *NASA
 Tech. Memo. 104566, Vol. 8*, S.B. Hooker and E.R. Fire-
 stone, Eds., 61 pp.

Vol. 9

Gregg, W.W., F.C. Chen, A.L. Mezaache, J.D. Chen, J.A.
 Whiting, 1993: The Simulated SeaWiFS Data Set, Ver-
 sion 1. *NASA Tech. Memo. 104566, Vol. 9*, S.B. Hooker
 and E.R. Firestone, Eds., 17 pp.

Vol. 10

Woodward, R.H., R.A. Barnes, C.R. McClain, W.E. Esaias,
 W.L. Barnes, and A.T. Mecherikunnel, 1993: Modeling of
 the SeaWiFS Solar and Lunar Observations. *NASA Tech.
 Memo. 104566, Vol. 10*, S.B. Hooker and E.R. Firestone,
 Eds., 26 pp.

Vol. 11

Patt, F.S., C.M. Hoisington, W.W. Gregg, and P.L. Coronado,
 1993: Analysis of Selected Orbit Propagation Models for
 the SeaWiFS Mission. *NASA Tech. Memo. 104566, Vol.
 11*, S.B. Hooker, E.R. Firestone, and A.W. Indest, Eds.,
 16 pp.

Vol. 12

E.R. Firestone and S.B. Hooker, 1993: SeaWiFS Technical Report Series Summary Index: Volumes 1–11. *NASA Tech. Memo. 104566, Vol. 12*, S.B. Hooker and E.R. Firestone, Eds., 28 pp.

Vol. 13

McClain, C.R., K.R. Arrigo, J. Comiso, R. Fraser, M. Darzi, J.K. Firestone, B. Schieber, E-n. Yeh, and C.W. Sullivan, 1993: Case Studies for SeaWiFS Calibration and Validation, Part 1. *NASA Tech. Memo. 104566, Vol. 13*, S.B. Hooker and E.R. Firestone, Eds., 52 pp., plus color plates.

Vol. 14

Mueller, J.L., 1993: The First SeaWiFS Intercalibration Round-Robin Experiment, SIRREX-1, July 1992. *NASA Tech. Memo. 104566, Vol. 14*, S.B. Hooker and E.R. Firestone, Eds., NASA Goddard Space Flight Center, Greenbelt, Maryland, 60 pp.

REPORT DOCUMENTATION PAGE

*Form Approved
OMB No. 0704-0188*

Public reporting burden for this collection of information is estimated to average 1 hour per response, including the time for reviewing instructions, searching existing data sources, gathering and maintaining the data needed, and completing and reviewing the collection of information. Send comments regarding this burden estimate or any other aspect of this collection of information, including suggestions for reducing this burden, to Washington Headquarters Services, Directorate for Information Operations and Reports, 1215 Jefferson Davis Highway, Suite 1204, Arlington, VA 22202-4302, and to the Office of Management and Budget, Paperwork Reduction Project (0704-0188), Washington, DC 20503.

1. AGENCY USE ONLY (Leave blank)	2. REPORT DATE September 1993	3. REPORT TYPE AND DATES COVERED Technical Memorandum	
4. TITLE AND SUBTITLE SeaWiFS Technical Report Series Volume 14, The First SeaWiFS Intercalibration Round-Robin Experiment, SIRREX-1, July 1992		5. FUNDING NUMBERS Code 900	
6. AUTHOR(S) James L. Mueller Series Editors: Stanford B. Hooker and Elaine R. Firestone			
7. PERFORMING ORGANIZATION NAME(S) AND ADDRESS(ES) Laboratory for Hydrospheric Processes Goddard Space Flight Center Greenbelt, Maryland 20771		8. PERFORMING ORGANIZATION REPORT NUMBER 93B00117	
9. SPONSORING/MONITORING AGENCY NAME(S) AND ADDRESS(ES) National Aeronautics and Space Administration Washington, D.C. 20546-0001		10. SPONSORING/MONITORING AGENCY REPORT NUMBER NASA TM-104566, Vol. 14	
11. SUPPLEMENTARY NOTES James L. Mueller: CHORS San Diego State University, San Diego California Elaine R. Firestone: General Sciences Corporation, Laurel, Maryland			
12a. DISTRIBUTION/AVAILABILITY STATEMENT Unclassified-Unlimited Subject Category 48 Report is available from the Center for AeroSpace Information (CASI), 7121 Standard Drive, Hanover, MD 21076-1320; (301)621-0390		12b. DISTRIBUTION CODE	
13. ABSTRACT (Maximum 200 words) This report presents the results of the first Sea-viewing Wide Field-of-view Sensor (SeaWiFS) Intercalibration Round-Robin Experiment (SIRREX-1), which was held at the Center for Hydro-Optics and Remote Sensing (CHORS) at San Diego State University (SDSU) on 27-31 July 1992. Oceanographic radiometers to be used in the SeaWiFS Calibration and Validation Program will be calibrated by individuals from the National Aeronautics and Space Administration's (NASA's) Goddard Space Flight Center (GSFC), CHORS, and seven other laboratories. The purpose of the SIRREX experiments is to assure the radiometric standards used in all of these laboratories are referenced to the same scales of spectral irradiance and radiance, which will be maintained by GSFC and periodically recalibrated by the National Institute of Standards and Technology (NIST). The spectral irradiance scale of GSFC's FEL lamp number F269 (recalibrated by NIST in October 1992) was transferred to lamps belonging to the 9 participating laboratories; 1 set of lamp transfer measurements (involving 4 of the lamps) was precise to within less than 1% and meets SeaWiFS goals, but a second set (involving another 14 lamps) did not. The spectral radiance scale of the GSFC 40-inch integrating sphere source was transferred to integrating sphere radiance sources belonging to four of the other laboratories. Reflectance plaques, used for irradiance-to-radiance transfer by five of the laboratories, were compared but spectral bidirectional reflectance distribution functions (BRDFs) were not determined quantitatively. Also reported here are results of similar comparisons (in October 1992) between the GSFC scales of spectral irradiance and radiance and those used by the Hughes/Santa Barbara Research Center (SBRC) to calibrate and characterize the SeaWiFS instruments. This first set intercalibration round-robin experiments was a valuable learning experience for all participants, and led to several important procedural changes, which will be implemented in the second SIRREX, to be held at CHORS in June 1993.			
14. SUBJECT TERMS SeaWiFS, Oceanography, Round-Robin, SIRREX, Intercalibration, Spectral Irradiance, Spectral Radiance Calibration, Lamps, Scale, Transfer, Sphere		15. NUMBER OF PAGES 65	
		16. PRICE CODE	
17. SECURITY CLASSIFICATION OF REPORT Unclassified	18. SECURITY CLASSIFICATION OF THIS PAGE Unclassified	19. SECURITY CLASSIFICATION OF ABSTRACT Unclassified	20. LIMITATION OF ABSTRACT UL